

norstar



2022
TRUCK BEDS

WELCOME



Thank you for choosing Norstar as your source for truck beds. It is our pleasure to serve your business in providing the highest quality truck beds and service bodies on the market. Your satisfaction is our number one goal and we want to ensure our business relationship is always rewarding and prosperous. Please feel free to contact us with any questions, concerns, or any suggestions that can help improve our service to you.

Norstar was founded in 2012 with a seasoned and experienced team that raised the first 20,000 square foot facility by their own hands from the ground up. Within the first few years, Norstar became a major player in the national truck bed market.

- In the first two years, Norstar facilities expanded to almost five times the size of the original shop space.
- In 2018, Norstar saw another addition in the new stacking bay, bringing the total to 360,000 square feet.
- By 2019, Norstar encompassed 450,000 square feet.
- Heading into 2022, Norstar has more than 10 acres under one roof at 600,000+ square feet!

ONE HECK OF A YEAR!





SIZE GUIDE

FORD

1998-2017 (2018+)	LENGTH	WIDTH	CTA	RUNNERS
Dually	8'6"	97"	56"/58"(2018+)	38"
Cab & Chassis	9'4"	94"/97"	60"	34"
Cab & Chassis	11'4"	94"/97"	84"	34"
Single Wheel Short Wheel Base	84"	84"	40"	38"
Single Wheel Long Wheel Base	8'6"	84"	56"/58"(2018+)	38"

GMC/CHEVROLET

2001-PRESENT	LENGTH	WIDTH	CTA	RUNNERS
Dually	8'6"	97"	56"	42"
Cab & Chassis	9'4"	94"/97"	60"	34"
Cab & Chassis	11'4"	94"/97"	84"	34"
Single Wheel Short Wheel Base	84"	84"	42"	42"
Single Wheel Long Wheel Base	8'6"	84"	56"	42"

DODGE

2003-PRESENT	LENGTH	WIDTH	CTA	RUNNERS
Dually	8'6"	97"	58"	42"
Cab & Chassis	11'4"	94"/97"	84"	34"
Cab & Chassis	9'4"	94"/97"	60"	34"
Single Wheel Short Wheel Base	84"	84"	38"	42"
Single Wheel Long Wheel Base	8'6"	84"	58"	42"
Megacab (Single Wheel)	84"	84"	38"	42"
Megacab (Dually)	84"	97"	38"	42"

WE RECOMMEND...

- *F-350 width 94", 97"
- *F-450 width 94", 97" with standard Headache Rack
- *F-550 width 97" with standard Headache Rack
- *2015 F-650 Requires 34.5" Runners

Prior to 2000 all measurements required

*2002 and earlier require 56" CTA and 38" runners on long bed

SD MODEL



Skirted Smooth Side with Front, Top and Rear Tool Boxes

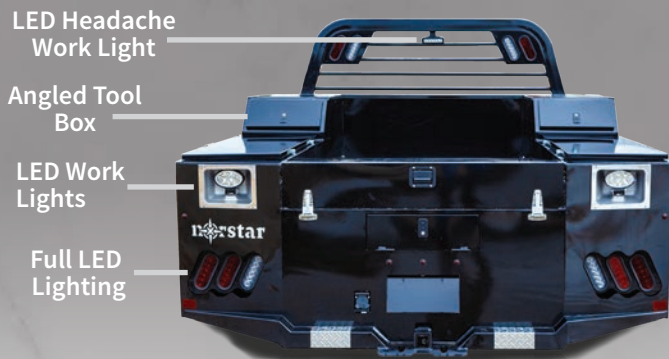

2022 SD

The Norstar SD Service bed is our best selling model, and for good reason too. It's perfect for day-to-day tasks. Featuring multiple standard tool boxes, adjustable smooth flare fenders, a rear lockable compartment, 12 Ga steel construction and much more, this bed is built tough.

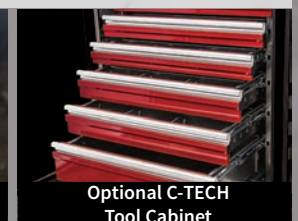
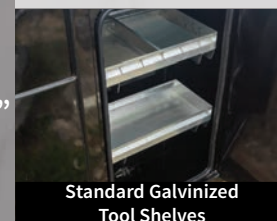

Photos may include optional features.

STANDARD FEATURES

Structural Steel Frame
2.5" 18.5k Rated Receiver
30k Rated 2 5/16" GN Ball
4" Runner Channels
Formed 3 x 3/16" Channel Cross Members
Steel Tube Head Rack with Cross Bars, Tail & Rev. Lights
Steel 1/8" Diamond Plate Floor
Fold-Down Tail Gate with Latch
Built in Gooseneck Well with Ball Mounted & Diam Plate Lid
Angled Fuel Filler Neck & DEF Ready
Skirted Rear Bumper with Anti-Slip Step
2 Angled Top Toolboxes & 2 Horizontal Top Toolboxes
4 Tool Boxes & Locking Chrome Paddle Latches (6 on 11'4")
Rear Lockable Compartment 27" x 38" - 78"
12Ga Steel Construction with 11Ga Bumper
Folding Tail Gate

LED Rear Work Lights
LED Head Rack Work Light
Adjustable Black Smooth Fenders Flares
Primer & Powder Coated Black
3/4" LED Marker Lights
Mudflap Brackets
4 Clear 6" Oval LED Reverse Lights
6 Red 6" Oval LED ST/TL/TN Lights
Single LED License Plate Light
Side & Rear Reflectors
All Lighting DOT Approved
Molded Sealed Harness with Resistors
4/5 & 7 Way Receiver Female Plug with Adapter
7 Way Plug in Gooseneck Well
Adjustable Galvanized Shelves in Front Tool Boxes





SD MODEL

Skirted Smooth Side with Front, Top and Rear Tool Boxes

2022 BASE MODELS

MODEL	LENGTH	WIDTH	CAB TO AXLE	WEIGHT	DECK WIDTH
Single Wheel Short Bed	84"	84"	38"(Dodge/Megacab), 40"(Ford), 42"(Chevy/GMC)	1450	50"
Mega Cab Dually	84"	90"	38"(Megacab Dually)	1735	50"
Single Wheel Long Bed	8'6"	84"	56"(Chevy/GMC, Ford), 58"(Dodge, Ford-Verify)	1705	50"
Dually (Bed Takeoff)	8'6"	90"	56"(Chevy/GMC, Ford), 58"(Dodge, Ford-Verify)	1735	50"
Cab & Chassis Single Wheel	9'4"	84"	60"(Chevy/GMC,Dodge, Ford)	1790	50"
Cab & Chassis Dually	9'4"	90"	60"(Chevy/GMC,Dodge, Ford)	1820	50"
Cab & Chassis Dually	11'4"	90"	84"(Chevy/GMC,Dodge, Ford)	2180	50"

*WEIGHT OF UNITS ARE APPROXIMATES ONLY AND SUBJECT TO CHANGE DEPENDING ON OPTIONS



APPEARANCE PACKAGES

These options are sold in groups. See list below for option description.

GROUP	INCLUDED OPTIONS
P02	X50 + F02
P03	W50 + F02 + W51 + W52 + X50
P07	W50 + F02 + W51 + W52 + X50 + X58

APPEARANCE OPTION REFERENCE LIST

- F02 = STAINLESS STEEL FENDERS
- W50 = CHROME ACCENT LIGHT PACKAGE
- W51 = CHROME LIGHT HOUSING
- W52 = CHROME LICENSE PLATE HOUSING
- X50 = ALUMINUM DIA PLATE SKIRT COVER
- X58 = ALUMINUM DIA PLATE TOP TOOLBOX COVERS

INDIVIDUAL OPTIONS

These options are available in combination & individually

CODE	DESCRIPTION
CT#	C-TECH TOOL CABINETS
I37	37.75" HEAD RACK
I39	39.75" HEAD RACK
I41	41.75" HEAD RACK
X01	15" GN TROUGH
U06	B&W TURNOVER BALL
HB1	BALE SPIKES

SL MODEL



Skirted Smooth Side with Front/Rear Tool Boxes and Rub Rails

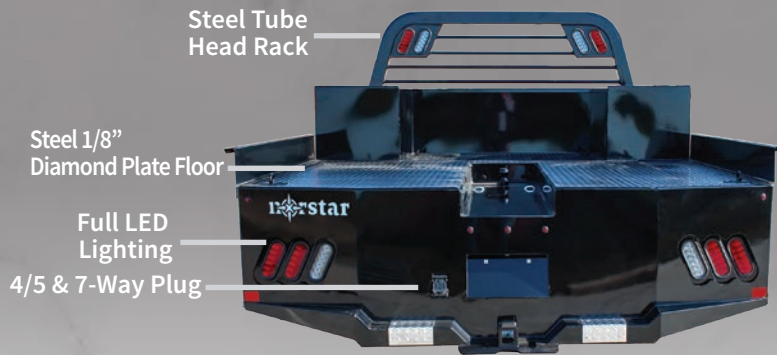

2022 SL

The Norstar SL Journeyman Bed is a marriage between our two most popular beds, the SD and ST. Our Journeyman Bed offers the best of both worlds with multiple tool boxes, a full-width deck, rub rails and stake pockets, and many more features for whatever the job throws at you.

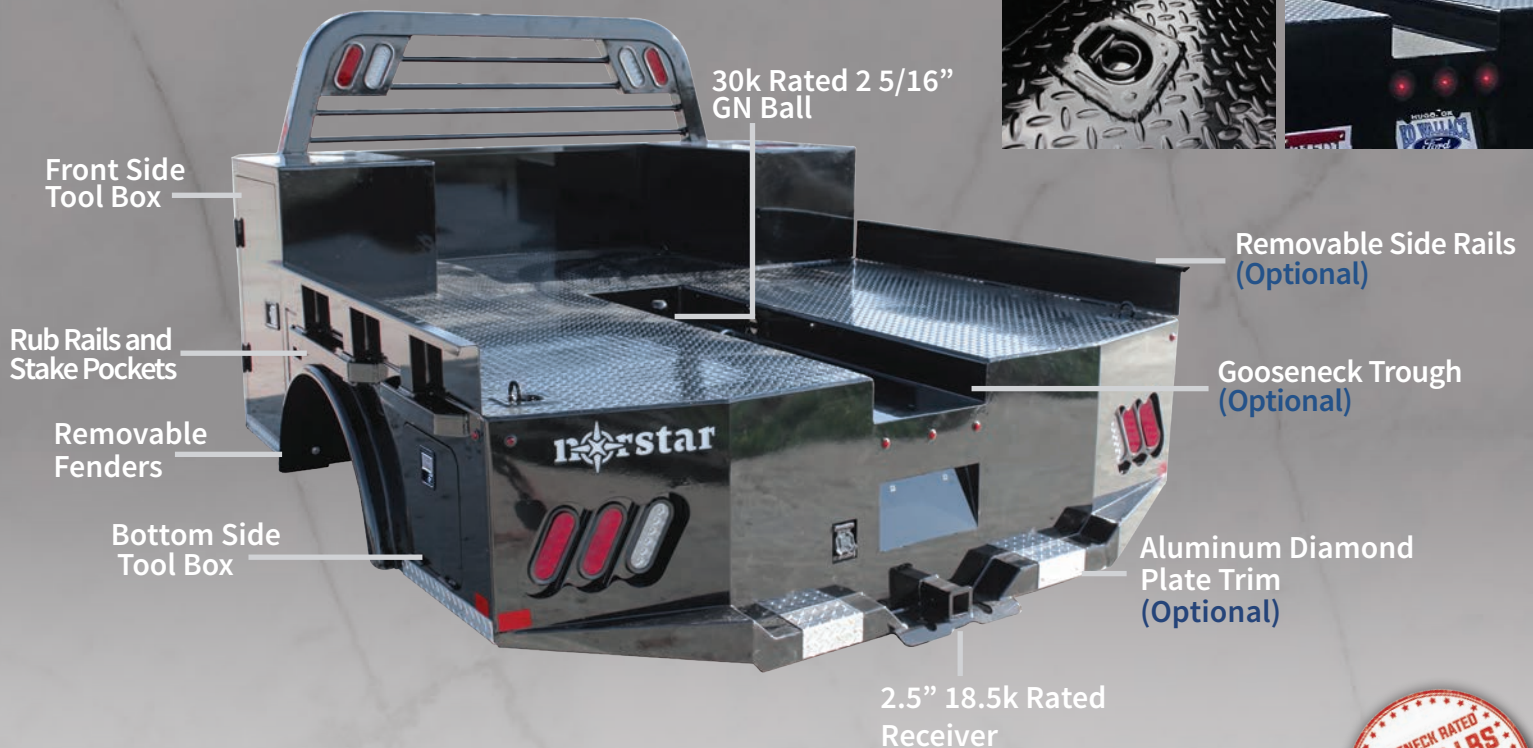
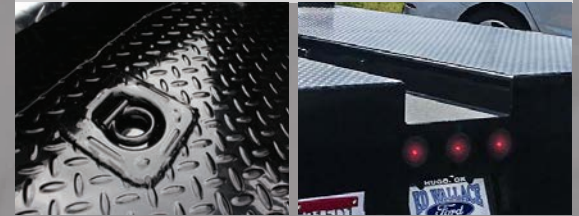

STANDARD FEATURES

Structural Steel Frame
2.5" 18.5k Rated Receiver
30k Rated 2 5/16" GN Ball
Formed 3 x 3/16" Channel Cross Members
Steel Tube Head Rack with Cross Bars, Tail & Rev. Lights
Steel 1/8" Diamond Plate Floor
Built in Gooseneck Well with Ball Mounted & Diam Plate Lid
Angled Fuel Filler Neck & DEF Ready
4 Tool Boxes & Locking Chrome Paddle Latches (6 on 11'4")
Skirted Rear Bumper with Anti-Slip Step
12Ga Steel Construction with 11Ga Bumper
Adjustable Black Smooth Fender Flares

3/4" LED Marker Lights
4 Clear 6" Oval LED Reverse Lights
6 Red 6" Oval LED ST/TL/TN Lights
Single LED License Plate Light
Side & Rear Reflectors
Primer & Powder Coated Black
7 Way Plug in Gooseneck Well
All Lighting DOT Approved
Molded Sealed Harness with Resistors
4/5 & 7 Way Receiver Female Plug with Adapter
Adjustable Galvanized Shelf in Front Tool Boxes
Mudflap Brackets





SL MODEL

Skirted Smooth Side with Front/Rear Tool Boxes and Rub Rails

2022 BASE MODELS

MODEL	LENGTH	WIDTH	CAB TO AXLE	WEIGHT	DECK WIDTH
Single Wheel Short Bed	84"	84"	38"(Dodge/Megacab), 40"(Ford), 42"(Chevy/GMC)	1450	50"
Mega Cab Dually	84"	90"	38"(Megacab Dually)	1735	50"
Single Wheel Long Bed	8'6"	84"	56"(Chevy/GMC, Ford), 58"(Dodge, Ford-Verify)	1705	50"
Dually (Bed Takeoff)	8'6"	90"	56"(Chevy/GMC, Ford), 58"(Dodge, Ford-Verify)	1735	50"
Cab & Chassis Single Wheel	9'4"	84"	60"(Chevy/GMC,Dodge, Ford)	1790	50"
Cab & Chassis Dually	9'4"	90"	60"(Chevy/GMC,Dodge, Ford)	1820	50"
Cab & Chassis Dually	11'4"	90"	84"(Chevy/GMC,Dodge, Ford)	2180	50"

*WEIGHT OF UNITS ARE APPROXIMATES ONLY AND SUBJECT TO CHANGE DEPENDING ON OPTIONS



APPEARANCE PACKAGES

These options are sold in groups. See list below for option description.

GROUP	INCLUDED OPTIONS
P02	X50 + F02
P03	W50 + F02 + W51 + W52 + X50

APPEARANCE OPTION REFERENCE LIST

- F02 = STAINLESS STEEL FENDERS
- W50 = CHROME ACCENT LIGHT PACKAGE
- W51 = CHROME LIGHT HOUSING
- W52 = CHROME LICENSE PLATE HOUSING
- X50 = ALUMINUM DIA PLATE SKIRT COVER

INDIVIDUAL OPTIONS

These options are available in combination & individually

CODE	DESCRIPTION
CT#	C-TECH TOOL CABINETS
I37	37.75" HEAD RACK
I39	39.75" HEAD RACK
I41	41.75" HEAD RACK
S52	REAR STAKE POCKETS
X01	15" GN TROUGH
U06	B&W TURNOVER BALL
HB1	BALE SPIKES

SR MODEL



Diamond Plate Side Rails with Stake Pockets and Rub Rail

2022 SR

The Norstar SR model is our flagship truck bed. Durable diamond plate construction, Structural Steel Frame and a 18.5k rated hitch will make this your everyday task-ready truck bed for years to come.

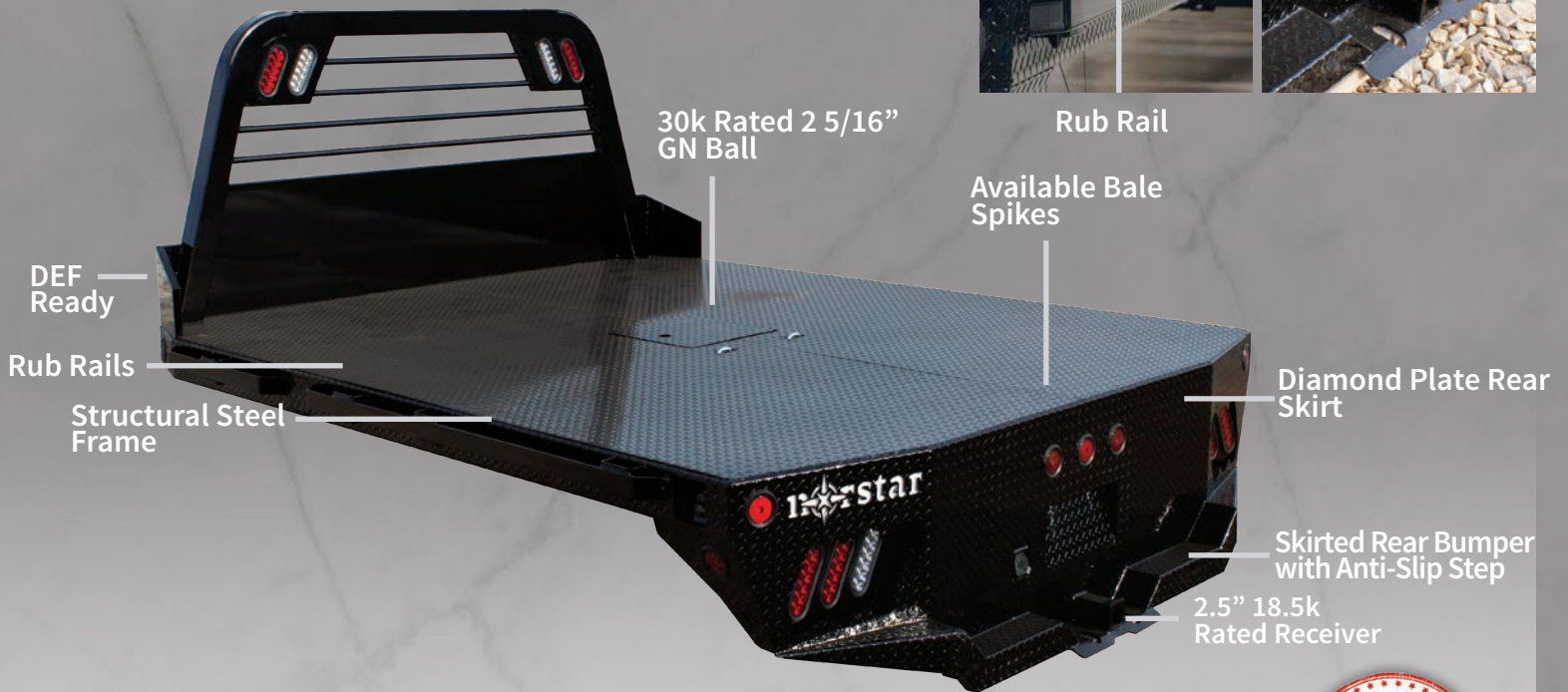
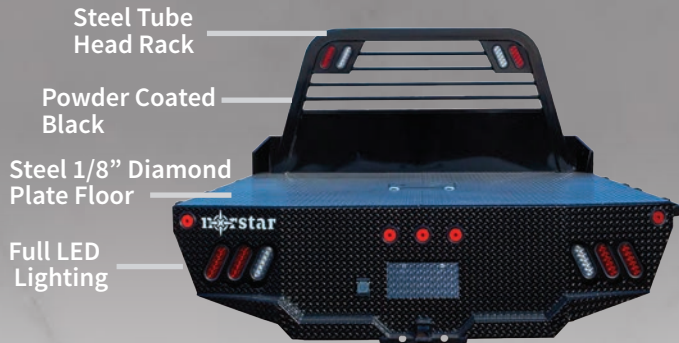

STANDARD FEATURES

- Structural Steel Frame
- 2.5" 18.5k Rated Receiver
- 30k Rated 2 5/16" GN Ball
- 4" Runner Channels (Adjustable on 84", 8'6" Only)
- Formed 3 x 3/16" Channel Cross Members
- Steel Tube Head Rack with Cross Bars, Tail and Reverse Lights
- Steel 1/8" Diamond Plate Floor
- Built-In Gooseneck Well with Ball Mounted and Diamond Plate Lid
- Angled Fuel Filler Neck and DEF Ready
- 11 Ga Skirted Rear Bumper
- 1/8" Diamond Plate Construction

- Primer & Powder Coated Black
- 2.5" LED Reflective Marker Lights
- 4 Clear 6" Oval LED Reverse Lights
- 6 Red 6" Oval LED ST/TL/TN Lights
- Single LED License Plate Light
- All Lighting DOT Approved
- Molded Sealed Harness with Resistors
- 4/5 & 7 Way Receiver Female Plug with Adapter
- Adjustable Mudflap Brackets
- 7 Way Plug in Gooseneck Well





SR MODEL

Diamond Plate Side Rails with Stake Pockets and Rub Rail

2022 BASE MODELS

MODEL	LENGTH	WIDTH	CAB TO AXLE	WEIGHT	DECK WIDTH
Single Wheel Short Bed	84"	84"	38"(Dodge/Megacab), 40"(Ford), 42"(Chevy/GMC)	985	80"
Mega Cab Dually	84"	97"	38"(Megacab Dually)	955	93"
Single Wheel Long Bed	8'6"	84"	56"(Chevy/GMC, Ford), 58"(Dodge, Ford-Verify)	1070	80"
Dually (Bed Takeoff)	8'6"	97"	56"(Chevy/GMC, Ford), 58"(Dodge, Ford-Verify)	1035	90", 93"
Cab & Chassis Single Wheel	9'4"	84"	60"(Chevy/GMC,Dodge, Ford)	1160	80"
Cab & Chassis Dually	9'4"	94", 97"	60"(Chevy/GMC,Dodge, Ford)	1180	90", 93"
Cab & Chassis Dually	11'4"	94", 97"	84"(Chevy/GMC,Dodge, Ford)	1250	90", 93"

*WEIGHT OF UNITS ARE APPROXIMATES ONLY AND SUBJECT TO CHANGE DEPENDING ON OPTIONS

INDIVIDUAL OPTIONS

These options are available in combination & individually

CODE	DESCRIPTION
I37	37.75" HEAD RACK
I39	39.75" HEAD RACK
I41	41.75" HEAD RACK
S52	REAR STAKE POCKETS
X01	15" GN TROUGH
U06	B&W TURNOVER BALL
HB1	BALE SPIKES



@dieselmxtt



@thatblue12v



@cummingtrailers

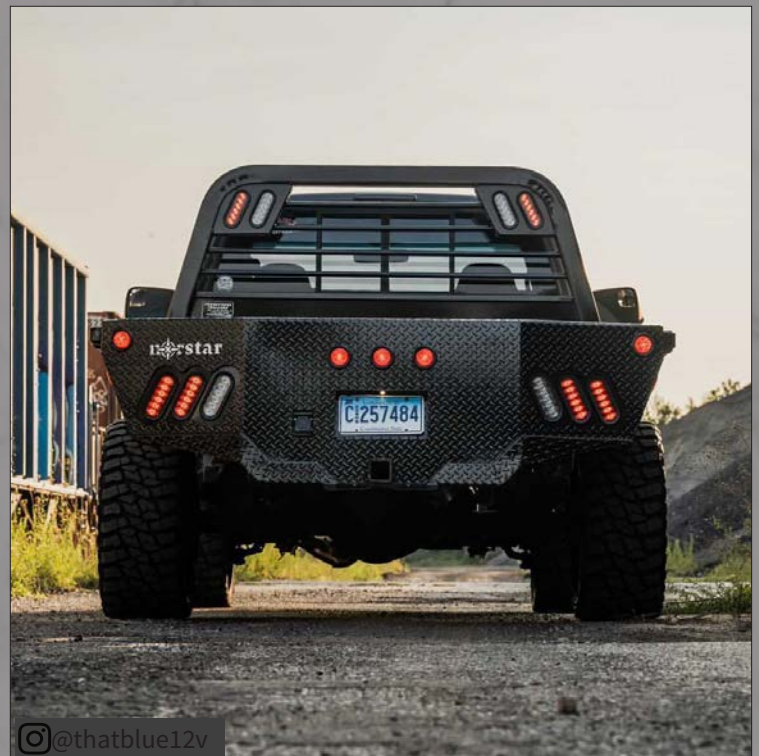

@thatblue12v

SF MODEL



Smooth Side Rails with Internal Stake Pockets

2022 SF

The SF Model Flat Bed keeps a low profile, but is full of features that make it a force to be reckoned with. With a 18.5k Rated Receiver and 30k Rated 2 5/16" GN Ball, this bed is a hauling monster.

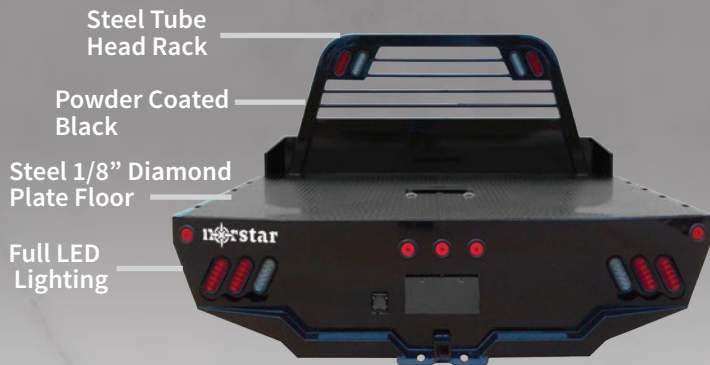

Smooth Rail



STANDARD FEATURES

- Structural Steel Frame
- 2.5" 18.5k Rated Receiver
- 30k Rated 2 5/16" GN Ball
- 4" Runner Channels (Adjustable on 84", 8'6" Only)
- Formed 3 x 3/16" Channel Cross Members
- Steel Tube Head Rack with Cross Bars, Tail and Reverse Lights
- Steel 1/8" Diamond Plate Floor
- Built-In Gooseneck Well with Ball Mounted and Diamond Plate Lid
- Angled Fuel Filler Neck
- Skirted Rear Bumper with Anti-Slip Step
- 11 Ga Steel Construction

- Primer & Powder Coated Black
- 2.5" LED Reflective Marker Lights
- 4 Clear 6" Oval LED Reverse Lights
- 6 Red 6" Oval LED ST/TL/TN Lights
- Single LED License Plate Light
- All Lighting DOT Approved
- Molded Sealed Harness with Resistors
- 4/5 & 7-Way Receiver Female Plug with Adapter
- Adjustable Mudflap Brackets
- 7 Way Plug in Gooseneck Well



2022 BASE MODELS

MODEL	LENGTH	WIDTH	CAB TO AXLE	WEIGHT	DECK WIDTH
Single Wheel Short Bed	84"	84"	38"(Dodge/Megacab), 40"(Ford), 42"(Chevy/GMC)	940	80"
Mega Cab Dually	84"	97"	38"(Megacab Dually)	950	93"
Single Wheel Long Bed	8'6"	84"	56"(Chevy/GMC, Ford), 58"(Dodge, Ford-Verify)	975	80"
Dually (Bed Takeoff)	8'6"	97"	56"(Chevy/GMC, Ford), 58"(Dodge, Ford-Verify)	1015	90", 93"
Cab & Chassis Single Wheel	9'4"	84"	60"(Chevy/GMC,Dodge, Ford)	1015	80"
Cab & Chassis Dually	9'4"	94", 97"	60"(Chevy/GMC,Dodge, Ford)	1080	90", 93"
Cab & Chassis Dually	11'4"	94", 97"	84"(Chevy/GMC,Dodge, Ford)	1130	90", 93"

*WEIGHT OF UNITS ARE APPROXIMATES ONLY AND SUBJECT TO CHANGE DEPENDING ON OPTIONS

INDIVIDUAL OPTIONS

These options are available in combination & individually

CODE	DESCRIPTION
I37	37.75" HEAD RACK
I39	39.75" HEAD RACK
I41	41.75" HEAD RACK
S52	REAR STAKE POCKETS
X01	15" GN TROUGH
U06	B&W TURNOVER BALL
HB1	BALE SPIKES



@weston_andal



@bigchimneydiesel



@riversidetrailersidaho

ST MODEL



Skirted Smooth Side with Front/Rear Tool Boxes and Rub Rails



2022 ST

The ST Model is a heavy-hauler. It comes loaded with four standard toolboxes, available bale spikes, rub rails and an optional goose-neck trough. The ST is built to carry whatever you need to wherever you need it.

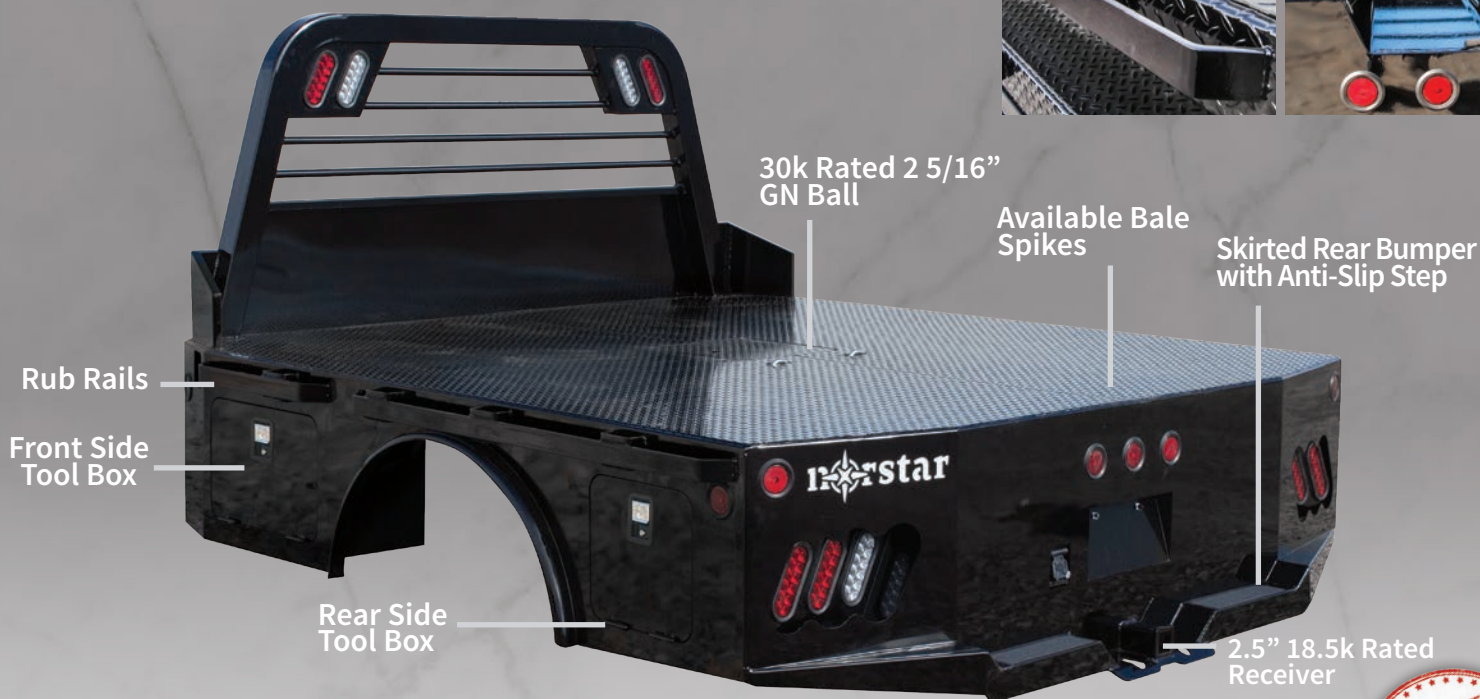
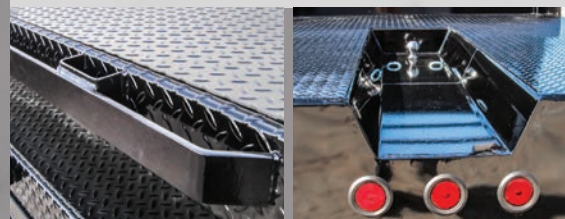

STANDARD FEATURES

Structural Steel Frame
2.5" 18.5k Rated Receiver
30k Rated 2 5/16" GN Ball
4" Runner Channels
Formed 3 x 3/16" Channel Cross Members
Steel Tube Head Rack with Cross Bars, Tail & Rev. Lights
Steel 1/8" Diamond Plate Floor
Built in Gooseneck Well with Ball Mounted & Diam Plate Lid
Angled Fuel Filler Neck & DEF Ready
Skirted Smooth Plate Rear Bumper with Anti-Slip Step
Removable Black Smooth Fender Flares
12Ga Steel Construction with 11Ga Bumper

Primer & Powder Coated Black
2.5" LED Reflective Marker Lights
4 Clear 6" Oval LED Reverse Lights
6 Red 6" Oval LED ST/TL/TN Lights
Single LED License Plate Light
All Lighting DOT Approved
Molded Sealed Harness with Resistors
4/5 & 7 Way Receiver Female Plug with Adapter
4 Tool Boxes & Locking Chrome Paddle Latches
Mudflap Brackets
7-Way Plug in Gooseneck Well





ST MODEL

Skirted Smooth Side with Front/Rear Tool Boxes and Rub Rails

2022 BASE MODELS

MODEL	LENGTH	WIDTH	CAB TO AXLE	WEIGHT	DECK WIDTH
Single Wheel Short Bed	84"	84"	38"(Dodge/Megacab), 40"(Ford), 42"(Chevy/GMC)	1045	80"
Mega Cab Dually	84"	97"	38"(Megacab Dually)	1155	93"
Single Wheel Long Bed	8'6"	84"	56"(Chevy/GMC, Ford), 58"(Dodge, Ford-Verify)	1275	80"
Dually (Bed Takeoff)	8'6"	97"	56"(Chevy/GMC, Ford), 58"(Dodge, Ford-Verify)	1295	90", 93"
Cab & Chassis Single Wheel	9'4"	84"	60"(Chevy/GMC, Dodge, Ford)	1320	80"
Cab & Chassis Dually	9'4"	94", 97"	60"(Chevy/GMC, Dodge, Ford)	1465	90", 93"
Cab & Chassis Dually	11'4"	94", 97"	84"(Chevy/GMC, Dodge, Ford)	1585	90", 93"

*WEIGHT OF UNITS ARE APPROXIMATES ONLY AND SUBJECT TO CHANGE DEPENDING ON OPTIONS



APPEARANCE PACKAGES

These options are sold in groups. See list below for option description.

GROUP	INCLUDED OPTIONS
P02	X50 + F02
P03	W50 + F02 + W51 + W52 + X50

APPEARANCE OPTION REFERENCE LIST

- F02 = STAINLESS STEEL FENDERS
- W50 = CHROME ACCENT LIGHT PACKAGE
- W51 = CHROME LIGHT HOUSING
- W52 = CHROME LICENSE PLATE HOUSING
- X50 = ALUMINUM DIA PLATE SKIRT COVER



INDIVIDUAL OPTIONS

These options are available in combination & individually

CODE	DESCRIPTION
I37	37.75" HEAD RACK
I39	39.75" HEAD RACK
I41	41.75" HEAD RACK
S52	REAR STAKE POCKETS
X01	15" GN TROUGH
U06	B&W TURNOVER BALL
HB1	BALE SPIKES



WH MODEL



Skirted Smooth Side with Four Tool Boxes

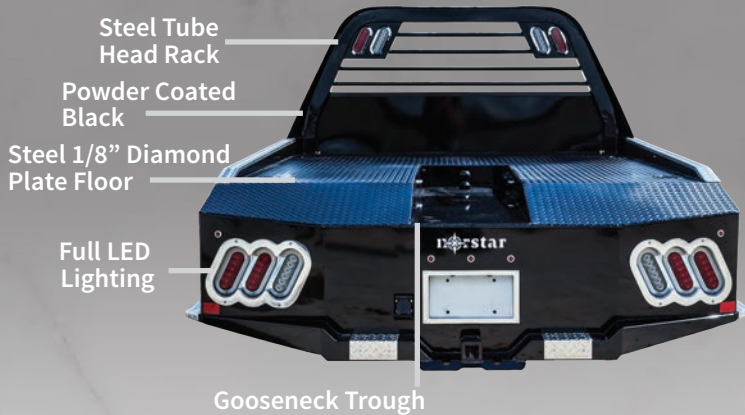

2022 WH

The WH Model is our top of the line bed. This Western Hauler Truck Bed comes ready to impress with its diamond plate floor Structural Steel Frame and head-turning standard aluminum trim package.

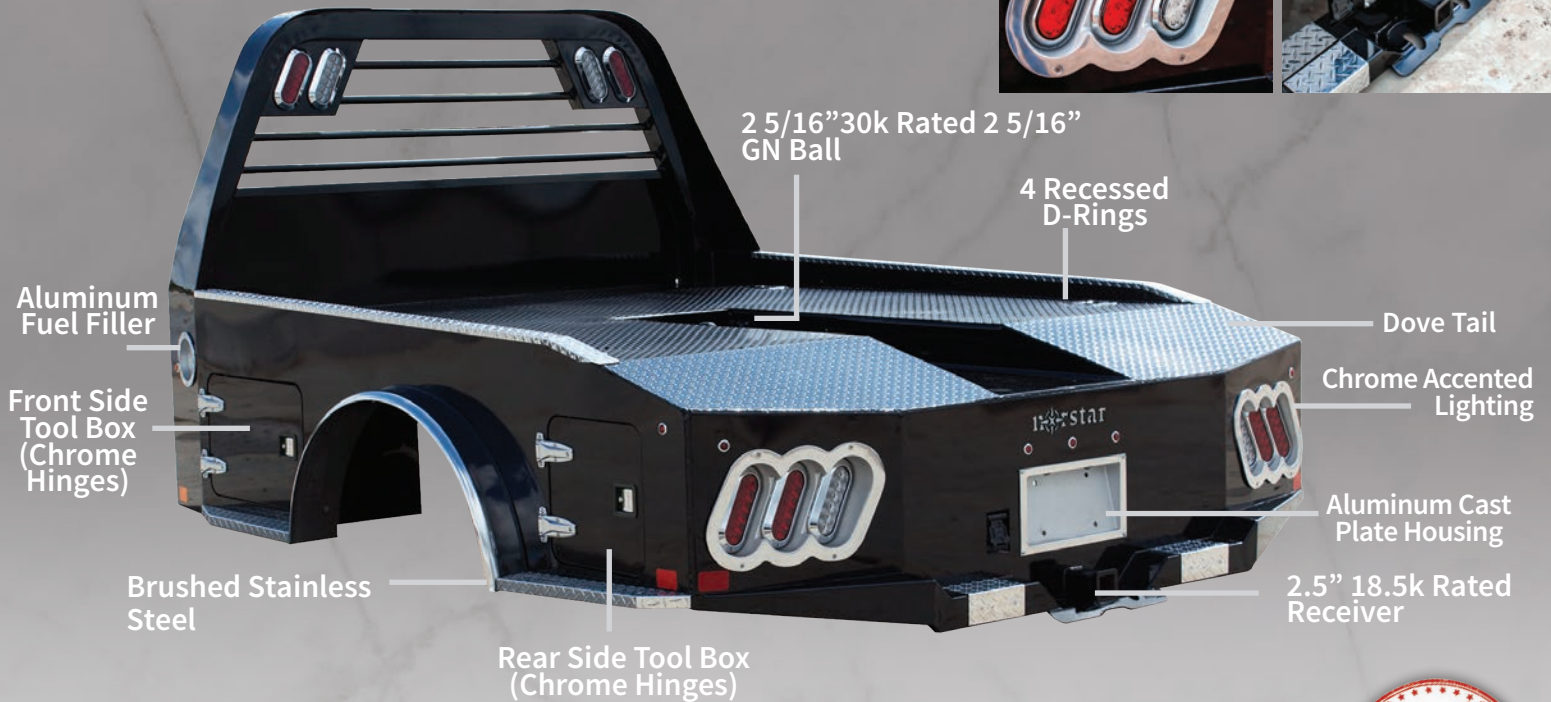

STANDARD FEATURES

- Structural Steel Frame
- 2.5" 18.5k Rated Receiver
- 30k Rated 2 5/16" GN Ball
- Formed 3 x 3/16" Channel Cross Members
- Steel Tube Head Rack with Cross Bars, Tail & Rev. Lights
- Built-in Gooseneck Well with Ball Mounted & Diam Plate Lid
- Skirted Rear Bumper with Anti-Slip Step
- 2 Aluminum Cast Angled Fuel Fillers
- Aluminum Cast Tail Light Housing
- Aluminum Cast License Plate Housing
- Aluminum Trim Package
- 11Ga Steel Construction with 10Ga Bumper
- 4 Side Swing Tool Box Doors with Chrome Hinges (Except Megacab)
- 7 Way Plug in Gooseneck Trough

- 4 Recessed D-Rings
- 18" Gooseneck Trough
- Dove Tail
- Primer & Powder Coated Black
- Chrome Accent Lighting
- 2.5" LED Reflective Marker Lights
- 4 Clear 6" Oval LED Rev. Lights
- 6 Red 6" Oval LED ST/TL/TN Lights
- Single LED License Plate Light
- All Lighting DOT Approved
- Molded Sealed Harness with resistors
- 4/5 & 7 Way Receiver Female Plug with Adapter
- Mudflap Brackets
- Steel 1/8" Diamond Plate Floor





WH MODEL

Skirted Smooth Side with Four Tool Boxes

2022 BASE MODELS

MODEL	LENGTH	WIDTH	CAB TO AXLE	WEIGHT	DECK WIDTH
Single Wheel Short Bed	84"	78"	38"(Dodge/Megacab), 40"(Ford), 42"(Chevy/GMC)	915	74"
Mega Cab Dually	84"	88"	38"(Megacab Dually)	965	88"
Single Wheel Long Bed	8'6"	78"	56"(Chevy/GMC, Ford), 58"(Dodge, Ford-Verify)	1095	74"
Dually (Bed Takeoff)	8'6"	84", 88"	56"(Chevy/GMC, Ford), 58"(Dodge, Ford-Verify)	1290	80", 84"
Cab & Chassis Single Wheel	9'4"	78"	60"(Chevy/GMC,Dodge, Ford)	1235	74"
Cab & Chassis Dually	9'4"	84", 88"	60"(Chevy/GMC,Dodge, Ford)	1355	80", 84"
Cab & Chassis Dually	11'4"	84", 88"	84"(Chevy/GMC,Dodge, Ford)	1515	80", 84"

*WEIGHT OF UNITS ARE APPROXIMATES ONLY AND SUBJECT TO CHANGE DEPENDING ON OPTIONS



INDIVIDUAL OPTIONS

These options are available in combination & individually

CODE	DESCRIPTION
I37	37.75" HEAD RACK
I39	39.75" HEAD RACK
I41	41.75" HEAD RACK
U06	B&W TURNOVER BALL



SC MODEL



Skirted Smooth Side with Front, Top and Rear Tool Boxes



2022 SC

The Norstar SC Service bed is a great addition to any job site. Our precision built Service Body offers multiple standard tool boxes, polished fenders, 12Ga steel construction and more for your daily tasks.



Standard Galvanized Tool Shelves



STANDARD FEATURES



- Structural Steel Frame
- 2.5" 18.5k Rated Receiver
- 4" Runner Channels
- Formed 3 x 3/16" Channel Cross Members
- Steel 1/8" Diamond Plate Floor
- Angled Fuel Filler Neck & DEF Ready
- Skirted Rear Bumper with Anti-Slip Step
- 3 Tool Boxes & Locking Chrome Paddle Latches on Each Side
- Adjustable Galvanized Shelves
- Rear Lockable Compartment 27" x 38" - 78"
- 12 Ga Steel Construction with 11Ga Bumper
- Rear Master Lock System

- 3/4" LED Marker Lights
- Primer & Powder Coated White
- Removable White Smooth Fender Flares
- 2 Clear 6" Oval LED Reverse Lights
- 4 Red 6" Oval LED ST/TL/TN Lights
- Single LED License Plate Light
- Side & Rear Reflectors
- All Lighting DOT Approved
- Molded Sealed Harness with Resistors
- 4/5 & 7 Way Receiver Female Plug with Adapter
- Mudflap Brackets
- [GN Well NOT Available - B&W Turnover IS Available]



SC MODEL

Skirted Smooth Side with Front, Top and Rear Tool Boxes

2022 BASE MODELS

MODEL	LENGTH	WIDTH	CAB TO AXLE	WEIGHT	DECK WIDTH
Single Wheel Short Bed	84"	84"	38"(Dodge/Megacab), 40"(Ford), 42"(Chevy/GMC)	1735	50"
Mega Cab Dually	84"	90"	38"(Megacab Dually)	1735	50"
Single Wheel Long Bed	8'6"	84"	56"(Chevy/GMC, Ford), 58"(Dodge, Ford-Verify)	2100	50"
Dually (Bed Takeoff)	8'6"	90"	56"(Chevy/GMC, Ford), 58"(Dodge, Ford-Verify)	1740	50"
Cab & Chassis Single Wheel	9'4"	84"	60"(Chevy/GMC, Dodge, Ford)	2300	50"
Cab & Chassis Dually	9'4"	90"	60"(Chevy/GMC, Dodge, Ford)	1840	50"
Cab & Chassis Dually	11'4"	90"	84"(Chevy/GMC, Dodge, Ford)	2080	50"

*WEIGHT OF UNITS ARE APPROXIMATES ONLY AND SUBJECT TO CHANGE DEPENDING ON OPTIONS



@cummingtrailers

APPEARANCE PACKAGES

These options are sold in groups. See list below for option description.

GROUP	INCLUDED OPTIONS
P02	X50 + F02
P03	W50 + F02 + W51 + W52 + X50
P04	F89 (Top Boxes & Lids)
P05	W50 + F02 + W51 + W52 + X50 + F89
P06	X50 + F02 + F89

APPEARANCE OPTION REFERENCE LIST

- F02 = STAINLESS STEEL FENDERS
- F89 = TOP TOOLBOXES AND LIDS
- W50 = CHROME ACCENT LIGHT PACKAGE
- W51 = CHROME LIGHT HOUSING
- W52 = CHROME LICENSE PLATE HOUSING
- X50 = ALUMINUM DIA PLATE SKIRT COVER



@dannysasphalt

INDIVIDUAL OPTIONS

These options are available in combination & individually

CODE	DESCRIPTION
CT#	C-TECH TOOL CABINETS
I37	37.75" HEAD RACK
I39	39.75" HEAD RACK
I41	41.75" HEAD RACK
U06	B&W TURNOVER BALL



@bigchimneydiesel

AR MODEL



Aluminum Head Rack

Full LED Lighting

Aluminum Side Rails with Stake Pockets and Rub Rails

MODEL	LENGTH	WIDTH	CAB TO AXLE
Single Wheel Short Bed	84"	84"	40"
Mega Cab Dually	84"	97"	38"
Single Wheel Long Bed	8'6"	84"	56"
Dually (Bed Takeoff)	8'6"	97"	56"
Cab & Chassis Single Wheel	9'4"	84"	60"
Cab & Chassis Dually	9'4"	97"	60"
Cab & Chassis Dually	11'4"	97"	84"



Optional Chrome Light Package



Optional Removable 6" Smooth Aluminum Rail Extensions



7-Way Plug in Gooseneck Well

*Optional Feature

Rub Rails

Solid Steel Subframe

4/5 & 7-Way Plug

Skirting Bumper w Anti-Slip Step

2.5" 18.5k Rated Receiver

Continuing Norstar's legacy of quality built products, we introduce our 2022 Aluminum Line. With a gooseneck hitch rating of trailer weight at 30,000 Lbs and a receiver hitch rated at 18,500 Lbs the AR and AT bring some serious towing power to your arsenal with corrosion resistant construction.



Aluminum Side Rails Stake Pockets and Rub Rails

MODEL	LENGTH	WIDTH	CAB TO AXLE
Single Wheel Short Bed	84"	84"	38", 40", 42"
Mega Cab Dually	84"	97"	38"
Single Wheel Long Bed	8'6"	84"	56", 58"
Dually (Bed Takeoff)	8'6"	97"	56", 58"
Cab & Chassis Single Wheel	9'4"	84"	60"
Cab & Chassis Dually	9'4"	97"	60"
Cab & Chassis Dually	11'4"	97"	84"



Photos may include optional features.



UNDERMOUNT OR STACKABLE TOOL BOXES

Part #	Length	Width	Depth	Latches
S43610021BK	18"	16"	12"	1
S43610022BK	24"	16"	12"	1
S43610024BK	30"	16"	12"	1
S43610023BK	24"	16"	16"	1
S43610040BK	30"	16"	16"	1
S43610060BK	18"	18"	18"	1
S43610061BK	24"	18"	18"	1
S43610062BK	36"	18"	18"	1
S43610063BK	48"	18"	18"	1
S43610064BK	60"	18"	18"	2



Max Box Sizes

Single 84"	18x16x12
Dually 8'6"	24x16x16
Dually 9'4"	30x16x16
Dually 11'4"	60x16x16
Single 8'6"	24x16x12
Single 9'4"	30x16x12

NOTE: Part No. will be used when item is sold individually.
Option Code will be used when mounted to truck bed.

PLUG-N-PLAY INSTALLATION ADAPTERS



Part #	Description
301300060	FORD, CAB CHASS (YEAR 2000-2019) (FCA-01)
301300061	DODGE, CAB CHASS (YEAR 2000-2019) (DCA-01)
301300062	FORD, BOX DELETE (YEAR 2011-2016) (FBDA-01)
301300063	GM, ADAPTER (1YEAR 2014-2015) (GMA-01)
301300150	FORD, BOX DELETE with CAMERA (YEAR 2011-2016)(FBDSA-01)
301300066	FORD BOX DELETE (YEAR 2017-2019) (FBDA-02)
301300067	GM (YEAR 2016-2019) (GMA -2016)
301300068	UNIVERSAL / DODGE BOX DELETE GENERIC HARD WIRE
301300171	GM CAB & CHASS 2020-CURNT, (GMA -05)
301300172	GM BED REMOVAL 2020, (GMA -06)
301300146	FORD, CAB CHASS (YEAR 2020-2021)(JCTS564)



SIDE RAIL EXTENSION

Part #	Length	Description
S43607022BK	68.25"	ST, SF and old SR 84" Bed
S43607041BK	68.25"	SR 84" Bed
S43607021BK	84"	ST, SF and old SR 8'6" Bed
S43607043BK	84"	SR 8'6" Bed
S43607023BK	96"	SF 9'4" Bed
S432060014BK	96"	ST and old SR 9'4" Bed
S0800103-02BK	96"	SR 9'4" Bed
S43607020BK	120"	ST and SR 11'4" Bed
S0800104-01BK	120"	SF 11'4" Bed



OTHER PARTS

Part #	Description
S43006006BK	HEAD RACK SPARE TIRE MOUNTING KIT
S430140108	HARDWARE KIT, UNI. MOUNTING PLATES
300400001	SINGLE WHEEL MUD FLAP 14" x 22" (PAIR)
300400002	DUALLY MUD FLAP 20" x 22" (PAIR)

C-TECH AND TOOL CABINETS

norstar				C-TECH MANUFACTURING ALUMINUM CARTS, CABINETS & DRAWERS			
MODEL	L	W	CTA	FRONT (A)	SECOND FRONT (B)	HORIZONTAL (C)	REAR (D)
SC	8'6"	84"	56", 58"	1402007 - 22 x 26.8 x 14.5	Not available	1402010 39 x 10.6 x 14.5	Not Available
	9'4"	84"	60"	1402007 - 22 x 26.8 x 14.5	Not available	1402010 39 x 10.6 x 14.5	Not Available
	8'6"	90"	56", 58"	1402008 - 22 x 26.8 x 18.5	Not available	1402011 39 x 10.6 x 18.5	Not Available
	9'4"	90"	60"	1402008 - 22 x 26.8 x 18.5	Not available	1402011 39 x 10.6 x 18.5	1402015 - 17.77 x 26.8 x 18.5
	11'4"	90"	84"	1402008 - 22 x 26.8 x 18.5	1402009 - 16 x 26.8 x 18.5	1402011 39 x 10.6 x 18.5	1402015 - 17.75 x 26.8 x 18.5

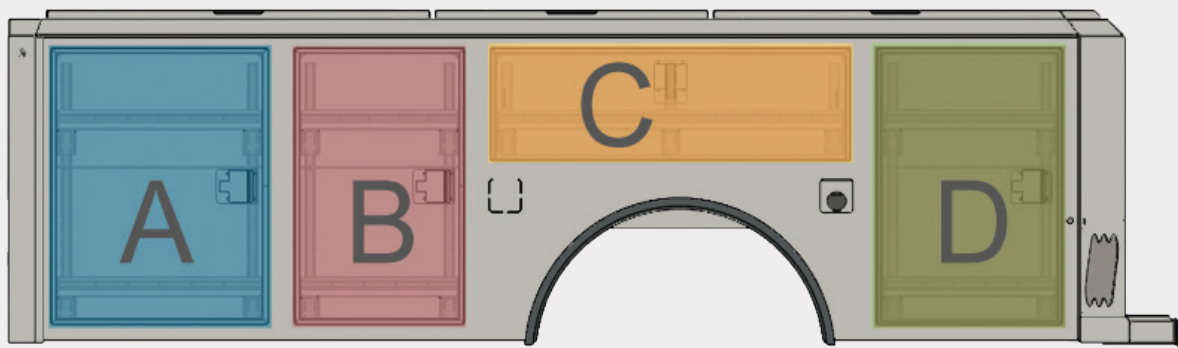

MODEL	L	W	CTA	FRONT (A)
SD	84"	90"	38", 40", 42"	Not Available
	8'6", 9'4", 11'4"	84"	56", 58", 60", 84"	1402004 - 14.5 x 26.8 x 14.5
	8'6", 9'4", 11'4"	90"	56", 58", 60", 84"	1402005 - 14.5 x 26.8 x 18.5

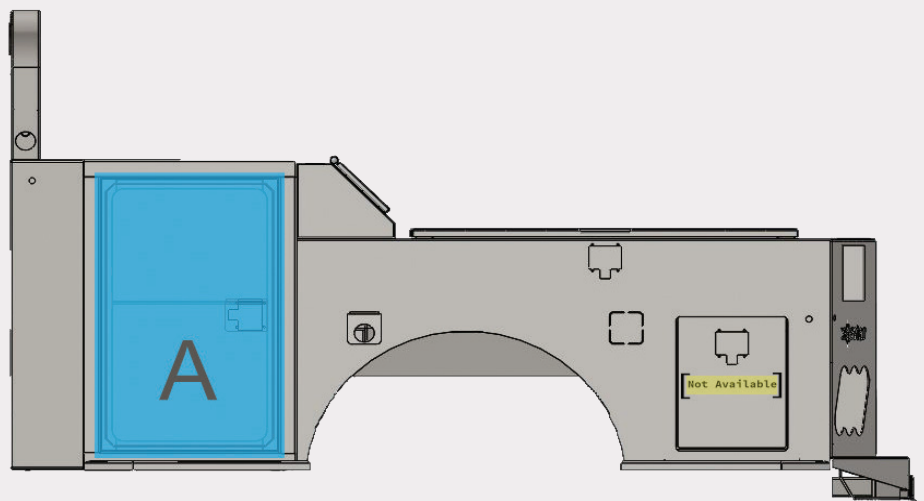

DEALER PRICING AVAILABLE AT NORSTARPARTS.COM



DISCLAIMER

This Product Guide contains information concerning technical descriptions of components, features and options available for each particular truck bed.

We hope you find this information helpful to you in your sales. To ensure better communication, we ask that you carefully read the Warranty Procedure Information, Terms of Sale and Sales Order Information.

This Product Guide is the property of Norstar Trailers, LLC. The information contained herein is confidential and to be used by Norstar Trailers, LLC employees and authorized dealers only. The information and specifications contained in this booklet are subject to change at any time without notice.

LIMITED WARRANTY

All warranty claims must be processed by an Authorized Norstar Dealer. To initiate a warranty claim, please contact an Authorized Norstar Dealer. You can locate your nearest Authorized Norstar Dealer here: http://www.norstarcompany.com/locate_dealer.cfm.

Online registration of the product within 30 days from date of first retail purchase is required to obtain the coverages provided by this Limited Warranty. You can register your product here: <https://norstarwarranty.com/home/warrantyregistration>

MANUFACTURER'S LIMITED WARRANTY

Subject to the conditions, limitations and exclusions noted below, Norstar Trailers LLC ("Norstar") warrants each new Norstar Truck Beds as provided below.

1. Three Year Materials and Workmanship Limited Warranty

Norstar warrants each new Norstar Truck Bed to be free from defects in materials and workmanship for a period of three (3) years from the date of first retail purchase. Structural components covered by this warranty include: Hitch assembly, runners and crossmembers, skirt, and headache rack.

2. Six Month Finish Limited Warranty

Norstar warrants its paint finish to be consistent with industry standards for six (6) months from the date of original factory sale.

Any claim or issue arising under this Limited Warranty must be reported immediately to an Authorized Norstar Dealer and will be handled within a reasonable time after the truck bed is returned to an approved repair facility. Norstar will repair or replace, at its sole discretion, any parts or components found to be defective due to faulty materials or workmanship. **NORSTAR'S SOLE OBLIGATION AND BUYER'S SOLE REMEDY UNDER THIS LIMITED WARRANTY IS REPAIR OR REPLACEMENT AT NORSTAR'S ELECTION.**

All warranty repairs must be pre-authorized by Norstar in writing and are subject to commercially reasonable labor rates and material costs. All authorized warranty repairs must use factory authorized replacement parts unless otherwise agreed by Norstar. Transportation costs to and from the approved repair facility and associated costs are not covered by this Limited Warranty and will not be reimbursed.

THE EXPRESS WARRANTIES SET FORTH HEREIN ARE THE EXCLUSIVE WARRANTIES OF NORSTAR, AND NO OTHER WARRANTY, EITHER EXPRESS OR IMPLIED, INCLUDING WARRANTIES OF MERCHANTABILITY OR FITNESS FOR A PARTICULAR USE OR PURPOSE, SHALL APPLY.

This Limited Warranty is not transferrable and extends only to the first retail purchaser. If the product is transferred or sold by the first retail purchaser, the express warranties provided herein are void.

Exclusions:

Parts or components not manufactured by Norstar, such as lights, hitch balls, mud flaps, latches, locks, hinges, wiring harnesses and connectors, C-tech drawers, and hydraulic systems and components are warranted by their respective manufacturers and are excluded from this Limited Warranty.

Parts, components or other items found to be altered or modified from their original condition without prior authorization of Norstar are excluded from coverage under this Limited Warranty. Use of any extension in the factory receiver tube longer than 10.5 inches, measured from pin to ball center, will void the express warranties provided herein. Damages caused by negligence, accident, abuse, misuse, overload, corrosive materials, vehicle collision, failure to properly maintain the product, or catastrophic weather conditions are not covered by this Limited Warranty. Wear items such as flooring, paint, lights, batteries, hinges, bearings and hoses are not covered under this Limited Warranty for normal or expected wear and tear.

Damages sustained during delivery are not covered by this Limited Warranty. Delivery damages should be noted by the dealer at the time of delivery and reported. In order to file a shipping damage claim damages must be indicated on the original packing slip and photos must be taken at the time of delivery. Failure to note the packing slip and record photos of damages could result in a denied claim.

Cosmetic damages will not be covered if not reported by the dealer at the time of delivery. All cosmetic damages reported after first retail purchase will be denied.

Any Truck Bed used as a rental unit or as part of a rental unit is not covered by this Limited Warranty.

Limitations of Liability:

The remedies provided for in this Limited Warranty are exclusive, and the total liability of Norstar to any purchaser, whether based on contract, warranty, tort, strict liability or otherwise, shall not exceed the purchase price of the truck bed giving rise to the claim.

IN NO EVENT, WHETHER BASED ON OR ARISING UNDER CONTRACT, WARRANTY, TORT, STRICT LIABILITY OR OTHERWISE, SHALL NORSTAR BE LIABLE TO PURCHASER OR ANY THIRD PARTY FOR SPECIAL, INDIRECT, INCIDENTAL, CONSEQUENTIAL OR PUNITIVE DAMAGES OF ANY KIND OR CHARACTER (INCLUDING, BUT NOT LIMITED TO, TRUCK BED REMOVAL OR REINSTALLATION, LOSS OF USE, REVENUE, PROFITS, OR WAGES, INVENTORY OR USE CHARGES, TOWING CHARGES, TRANSPORTATION OR SHIPPING COSTS, FUEL COSTS, LODGING OR MEALS, COST OF CAPITAL, AND CLAIMS BY CUSTOMERS).

Warrantable paint repairs are limited to spot repairs and blending consistent with industry standards. Deterioration due to use or exposure, such as chipping, scratching, fading, cracks in caulk seam, road salt, tar, other chemicals, pressure washing, or damage by animals will not be covered. Rust streaking originating from areas where it is virtually impossible to achieve total paint or powder coat coverage, i.e. behind rub rails or where two or more metals adjoin, are consistent with industry standards and are not covered by this Limited Warranty.

Applicable Law / Disputes:

The rights and obligations of the parties under this Limited Warranty shall be interpreted and governed in all respects in accordance with the laws of the State of Texas, USA, exclusive of any choice of law rules or provisions. Any dispute arising out of or related to this Limited Warranty which is not resolved by the parties informally shall be adjudicated exclusively in the courts of Lamar County, Texas, USA.

Severability / Waiver:

If any portion of this Limited Warranty is held to be invalid or unenforceable by a court of competent jurisdiction, such portion shall be deemed modified to the extent necessary to make it valid and enforceable; or if it cannot be so modified, then such portion shall be deemed severed from this Limited Warranty, with the remaining portions of this Limited Warranty continuing in full force and effect.

Norstar makes no other express or implied warranties beyond those described in this Limited Warranty.

Questions regarding this Limited Warranty should be directed to:

Norstar Trailers LLC., 5500 FM 38N, Brookston, Texas 75421 / www.norstarcompany.com



MARCH 2013

0 SQ FT

OCTOBER 2013

20,000 SQ FT

APRIL 2014

54,000 SQ FT



SEPTEMBER 2015

78,000 SQ FT



2018

360,000 SQ FT



2020

450,000 SQ FT



2021

600,000 SQ FT





FOLLOW
THE
STAR

MAIN PHONE NUMBER
903-784-8900

V.12.2

5500 FM 38N, BROOKSTON, TX 75421