

2019 VAN STORAGE EQUIPMENT



# GM VAN SOLUTIONS

FOR SAVANA, EXPRESS AND CITY EXPRESS



[WWW.WEATHERGUARD.COM](http://WWW.WEATHERGUARD.COM)



# DESIGNED WITH THE PROFESSIONAL IN MIND

WEATHER GUARD® Van Solutions deliver unmatched organization, productivity, and durability, backed by a Limited Lifetime Warranty.



WEATHER GUARD® Van Solutions are ready to roll with game changing improvements based on years of research and your input. Completely retooled shelving, improved bulkheads, customizable organizational features, and a host of smart new accessories, designed around the common sense idea that tools and equipment belong on the shelf, not the floor.

## TABLE OF CONTENTS

Receive up to \$1,200 Upfit Cash Allowance on Weather Guard Interiors or roof racks for new Chevy Express or GMC Savana cargo vans!

Receive up to \$350 Upfit Cash Allowance on Weather Guard Interiors or roof racks for new Chevrolet City Express vans!

Eligible commercial customers will receive upfit assistance cash on eligible vehicles when you install Weather Guard van equipment on your new GM van. Equipment must be installed by an authorized Weather Guard upfitter.

*Program details are subject to change without notice. See your local GM dealer for eligibility and program details.*

<b>BASE PACKAGES</b> .....	<b>4-9</b>
Low-Roof, 155" WB .....	4-5
High-Roof, 155" WB .....	6-7
Chevrolet City Express .....	8-9
<b>BULKHEADS</b> .....	<b>10</b>
<b>ADJUSTABLE SHELVING</b> .....	<b>11</b>
<b>SECURE STORAGE</b> .....	<b>12</b>
<b>MOUNTING KITS</b> .....	<b>12</b>
<b>ACCESSORIES</b> .....	<b>13</b>
<b>CABINETS</b> .....	<b>16</b>
<b>DRAWER UNITS</b> .....	<b>17</b>
<b>ROOF RACKS</b> .....	<b>18-19</b>

The PRO PACKAGES for Express, Savana and City Express vans on the next few pages can be used as a complete upfit package or a starting point for a custom upfit. Van layout dimensions are on the back cover if you're looking for something more custom or just need some detailed information about your van's interior. If you need more help, your local WEATHER GUARD® Truck and Van Equipment distributor is a great resource for all your upfitting questions.

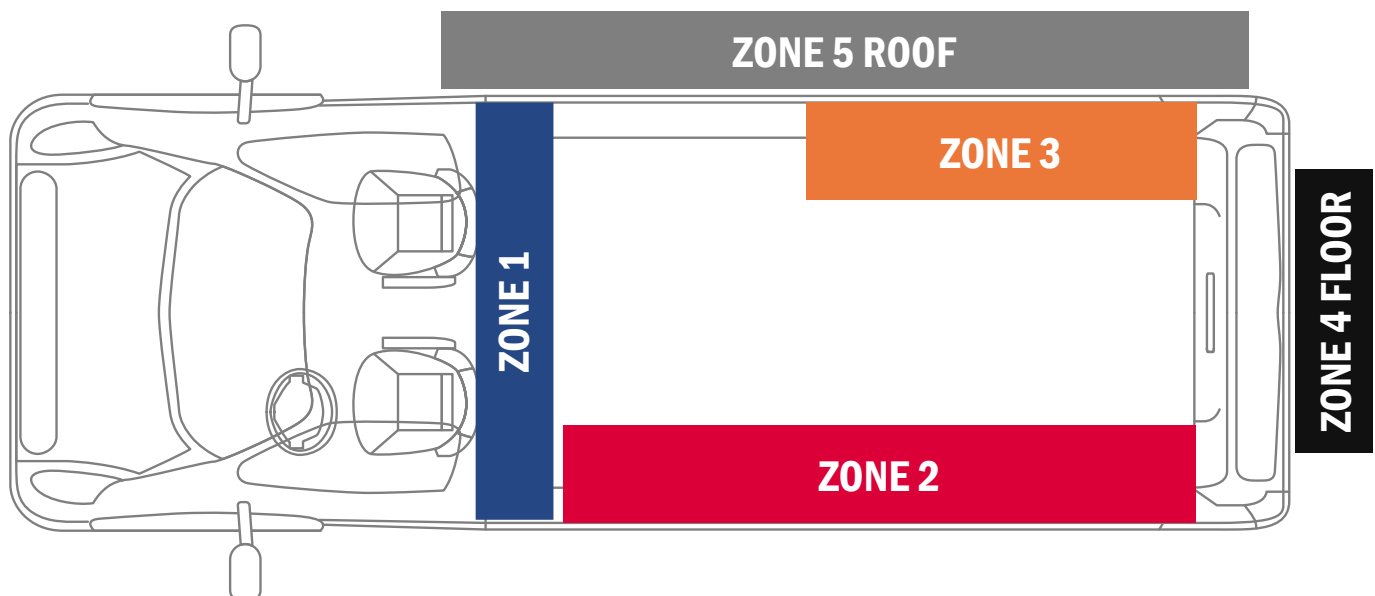

# LOW-ROOF PACKAGES 135" WHEEL BASE



From contractors to plumbers and electricians, we know that hard working professionals need flexibility to fit a new van to the job. These packages are customizable for your needs now or in the future with shelving and accessories starting on page 11.

**NEW!** Chevy Express/GMC Savana Mounting Kit

- Heavy gauge steel mounting plates distribute shelf load and provide secure mounting to van interior
- Mounts directly to reinforced weld nuts and cargo tie-downs or into existing holes (no drilling)
- Faster installation with reduced risk of damage to van during installation

MODEL	DESCRIPTION	WEIGHT
975401-3-01	Chevy Express 155" WB Mounting Kit	18 lbs.

## COMMERCIAL / BASE

DRIVER SIDE

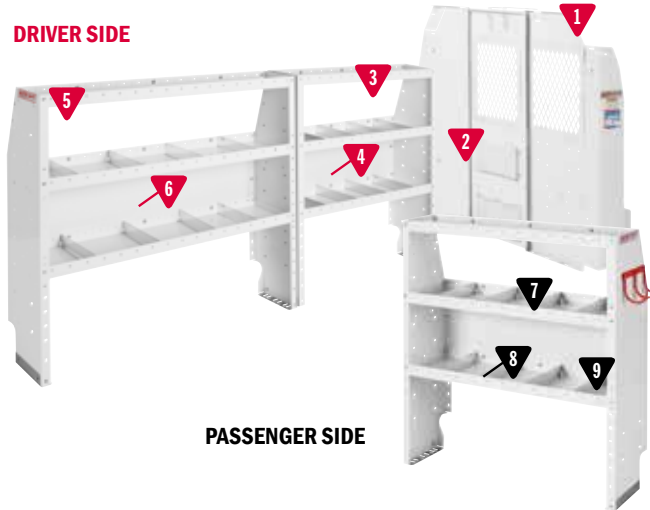

PASSENGER SIDE

### 600-8120R Commercial Shelving Package

MODEL	DESCRIPTION	QUANTITY
1	96102-3-01 Screen Bulkhead - GM Full Size Van	1
2	96901-3-01 Swing Door Conversion Kit	1
3	9354-3-03 Adjustable 3 Shelf Unit (42" x 44" x 13½")	1
4	9604-3-01 Accessory Back Panel (for 42" Shelf Unit 14½" tall)	1
5	9355-3-03 Adjustable 3 Shelf Unit (52" x 44" x 13½")	1
6	9605-3-01 Accessory Back Panel (for 52" Shelf Unit 14½" tall)	1
7	9354-3-03 Adjustable 3 Shelf Unit (42" x 44" x 13½")	1
8	9604-3-01 Accessory Back Panel (for 42" Shelf Unit 14½" tall)	1
9	9893-7-01 REDZONE 3 Hook Cord or Tool Holder	1
*10	975401-3-01 Van Shelf Mounting Kit - Chevy Express 155" WB	1

\* Not Shown

## GENERAL SERVICE / CONTRACTOR

DRIVER SIDE

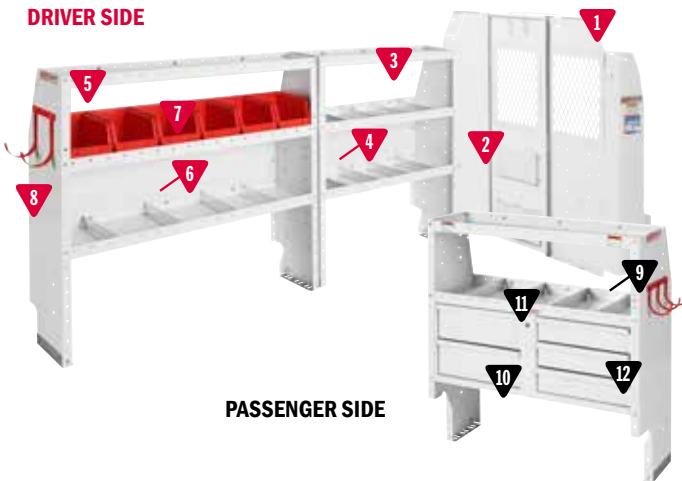

PASSENGER SIDE

### 600-8121R General Service/Contractor Package

MODEL	DESCRIPTION	QUANTITY
1	96102-3-01 Screen Bulkhead - GM Full Size Van	1
2	96901-3-01 Swing Door Conversion Kit	1
3	9354-3-03 Adjustable 3 Shelf Unit (42" x 44" x 13½")	1
4	9604-3-01 Accessory Back Panel (for 42" Shelf Unit 14½" tall)	1
5	9355-3-03 Adjustable 4 Shelf Unit (52" x 44" x 13½")	1
6	9605-3-01 Accessory Back Panel (for 52" Shelf Unit 14½" tall)	1
7	9859-7-01 REDZONE Medium 6 Bin Set (13")	1
8	9892-7-01 REDZONE 2 Hook Holder (5" diameter)	1
9	9381-3-03 Heavy Duty Shelf Unit (for Secure Storage Modules - 42" x 44" x 16")	1
10	9045-3-02 5 Drawer Secure Storage Module (42" x 17" x 16")	1
11	9604-3-01 Accessory Back Panel (for 42" Shelf Unit 14½" tall)	1
12	9893-7-01 REDZONE 3 Hook Cord or Tool Holder	1
*13	975401-3-01 Van Shelf Mounting Kit - Chevy Express 155" WB	1

\* Not Shown

# CABLE / PLUMBING

## 600-8122R Cable/Plumber Package

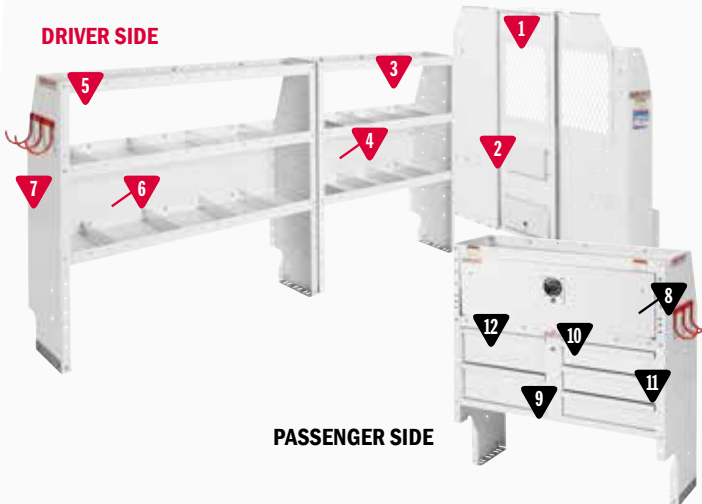

MODEL	DESCRIPTION	QUANTITY
1	96102-3-01 Screen Bulkhead - GM Full Size Van	1
2	96901-3-01 Swing Door Conversion Kit	1
3	9354-3-03 Adjustable 3 Shelf Unit (42" x 44" x 13½")	1
4	9604-3-01 Accessory Back Panel (for 42" Shelf Unit 14½" tall)	1
5	9355-3-03 Adjustable 4 Shelf Unit (52" x 44" x 13½")	1
6	9605-3-01 Accessory Back Panel (for 52" Shelf Unit 14½" tall)	1
7	9893-7-01 REDZONE 3 Hook Cord or Tool Holder	1
8	9381-3-03 Heavy Duty Shelf Unit (for Secure Storage Modules - 42" x 44" x 16")	1
9	9045-3-02 5 Drawer Secure Storage Module (42" x 17" x 16")	1
10	9604-3-01 Accessory Back Panel (for 42" Shelf Unit 14½" tall)	1
11	9893-7-01 REDZONE 3 Hook Cord or Tool Holder	1
12	9504-3-01 Shelf Door (for 42" Shelf Unit)	1
*13	975401-3-01 Van Shelf Mounting Kit - Chevy Express 155" WB	1

\* Not Shown

# HVAC / MECHANICAL

## 600-8123R HVAC/Mechanical Package

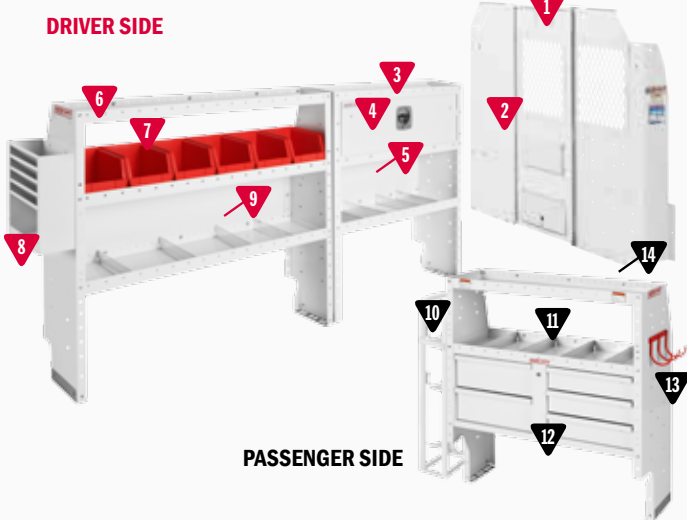

MODEL	DESCRIPTION	QUANTITY
1	96102-3-01 Screen Bulkhead - GM Full Size Van	1
2	96901-3-01 Swing Door Conversion Kit	1
3	9354-3-03 Adjustable 3 Shelf Unit (42" x 44" x 13½")	1
4	9504-3-01 Shelf Door (for 42" Shelf Unit)	1
5	9604-3-01 Accessory Back Panel (for 42" Shelf Unit 14½" tall)	1
6	9355-3-03 Adjustable 3 Shelf Unit (52" x 44" x 13½")	1
7	9355-7-01 REDZONE Medium 6 Bin Set (13")	2
8	9880-3-01 Literature Holder 6 Compartment	1
9	9605-3-01 Accessory Back Panel (for 52" Shelf Unit 14½" tall)	1
10	9863-3-01 Refrigerant Tank Rack (2x 30#, 1x 50#)	1
11	9381-3-03 Heavy Duty Shelf Unit (for Secure Storage Modules - 42" x 44" x 16")	1
12	9045-3-02 5 Drawer Secure Storage Module (42" x 17" x 16")	1
13	9893-7-01 REDZONE 3 Hook Cord or Tool Holder	1
*14	975401-3-01 Van Shelf Mounting Kit - Chevy Express 155" WB	1

\* Not Shown

# ELECTRICAL

## 600-8124R Electrical Package

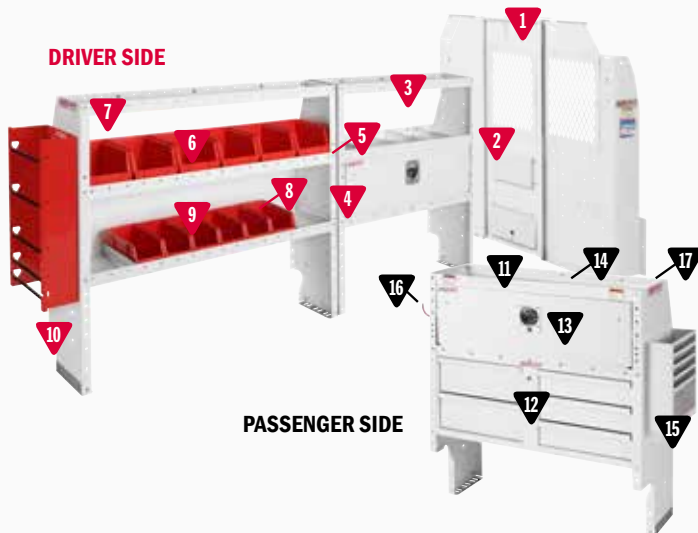

MODEL	DESCRIPTION	QUANTITY
1	96102-3-01 Screen Bulkhead - GM Full Size Van	1
2	96901-3-01 Swing Door Conversion Kit	1
3	9354-3-03 Adjustable 3 Shelf Unit (42" x 44" x 13½")	1
4	9504-3-01 Shelf Door (for 42" Shelf Unit)	1
5	9604-3-01 Accessory Back Panel (for 42" Shelf Unit 14½" tall)	1
6	9859-7-01 REDZONE Medium 6 Bin Set (13")	1
7	9355-3-03 Adjustable 3 Shelf Unit (52" x 44" x 13½")	1
8	9605-3-01 Accessory Back Panel (for 52" Shelf Unit 14½" tall)	1
9	9858-7-01 REDZONE Small 6 Bin Set (13")	1
10	9882-7-01 REDZONE Wire Spool Holder End Mount	1
11	9381-3-03 Heavy Duty Shelf Unit (for Secure Storage Modules - 42" x 44" x 16")	1
12	9045-3-02 5 Drawer Secure Storage Module (42" x 17" x 16")	1
13	9504-3-01 Shelf Door (for 42" Shelf Unit)	1
14	9604-3-01 Accessory Back Panel (for 42" Shelf Unit 14½" tall)	1
15	9880-3-01 Literature Holder 6 Compartment	1
16	9893-7-01 REDZONE 3 Hook Cord or Tool Holder	1
*17	975401-3-01 Van Shelf Mounting Kit - Chevy Express 155" WB	1

\* Not Shown

# LOW-ROOF PACKAGES 155" WHEEL BASE

Our Pro Packages help you organize your equipment and supplies, large and small. From recipis, drills and hand tools to expensive test equipment, the packages are customizable to meet your specific storage needs with a wide range of accessories starting on page 13.



**NEW!**

## Chevy Express/GMC Savana Mounting Kit

- Heavy gauge steel mounting plates distribute shelf load and provide secure mounting to van interior
- Mounts directly to reinforced weld nuts and cargo tie-downs or into existing holes (no drilling)
- Faster installation with reduced risk of damage to van during installation

MODEL	DESCRIPTION	WEIGHT
975402-3-01	Chevy Express/GMC Savana 155" WB Mounting Kit	20 lbs.

## COMMERCIAL / BASE

DRIVER SIDE

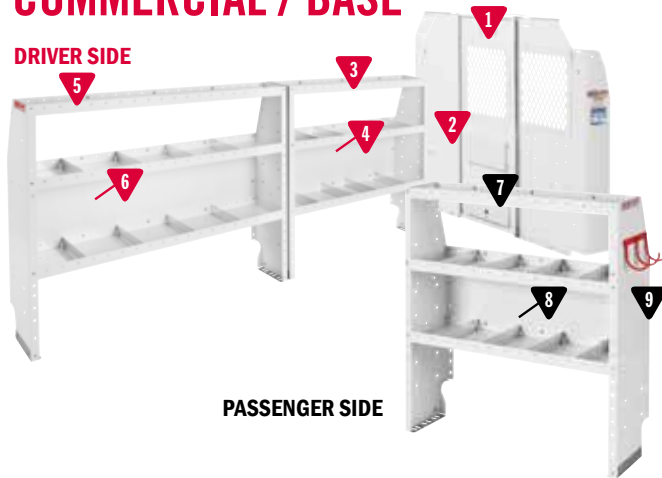

PASSENGER SIDE

## 600-8120L Commercial Shelving Package

MODEL	DESCRIPTION	QUANTITY
1	96102-3-01 Screen Bulkhead - Full Size Van	1
2	96901-3-01 Swing Door Conversion Kit	1
3	9355-3-03 Adjustable 3 Shelf Unit (52" x 44" x 13½")	1
4	9605-3-01 Accessory Back Panel (for 52" shelf unit 14½" tall)	1
5	9356-3-03 Adjustable 3 Shelf Unit (60" x 44" x 13½")	1
6	9606-3-01 Accessory Back Panel (or 60" shelf unit 14½" tall)	1
7	9354-3-03 Adjustable 4 Shelf Unit (42" x 44" x 13½")	1
8	9604-3-01 Accessory Back Panel (for 42" shelf unit 14½" tall)	1
9	9893-7-01 REDZONE 3 Hook Cord or Tool Holder	1
*10	975402-3-01 Van Shelf Mounting Kit - Chevy Express 155" WB	1

\* Not Shown

## GENERAL SERVICE / CONTRACTOR

DRIVER SIDE

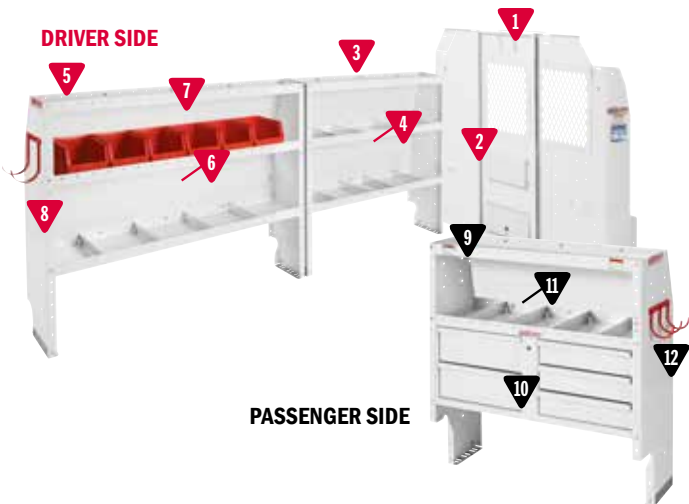

PASSENGER SIDE

## 600-8121L General Service/Contractor Package

MODEL	DESCRIPTION	QUANTITY
1	96102-3-01 Screen Bulkhead - Full Size Van	1
2	96901-3-01 Swing Door Conversion Kit	1
3	9355-3-03 Adjustable 3 Shelf Unit (52" x 44" x 13½")	1
4	9605-3-01 Accessory Back Panel (for 52" shelf unit 14½" tall)	1
5	9356-3-03 Adjustable 4 Shelf Unit (60" x 44" x 13½")	1
6	9606-3-01 Accessory Back Panel (for 60" shelf unit 14½" tall)	1
7	9859-7-01 REDZONE Medium 6 Bin Set (13")	1
8	9892-7-01 REDZONE 2 Hook Holder (5" diameter)	1
9	9381-3-03 Heavy Duty Shelf Unit (for Secure Storage Modules - 42" x 44" x 16")	1
10	9045-3-02 5 Drawer Secure Storage Module (42" x 17" x 16")	1
11	9604-3-01 Accessory Back Panel (for 42" shelf unit 14½" tall)	1
12	9893-7-01 REDZONE 3 Hook Cord or Tool Holder	1
*13	975402-3-01 Van Shelf Mounting Kit - Chevy Express 155" WB	1

\* Not Shown

## CABLE / PLUMBING

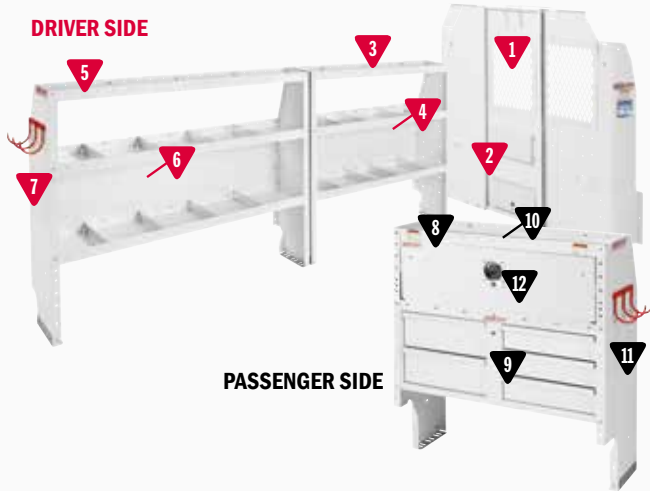

### 600-8122L Cable/Plumber Package

MODEL	DESCRIPTION	QUANTITY
1	96102-3-01 Screen Bulkhead - Full Size Van	1
2	96901-3-01 Swing Door Conversion Kit	1
3	9355-3-03 Adjustable 3 Shelf Unit (52" x 44" x 13½")	1
4	9605-3-01 Accessory Back Panel (for 52" Shelf Unit 14½" tall)	1
5	9356-3-03 Adjustable 3 Shelf Unit (60" x 44" x 13½")	1
6	9606-3-01 Accessory Back Panel (for 60" Shelf Unit 14½" tall)	1
7	9893-7-01 REDZONE 3 Hook Cord or Tool Holder	1
8	9381-3-03 Heavy Duty Shelf Unit (for Secure Storage Modules - 42" x 44" x 16")	1
9	9045-3-02 5 Drawer Secure Storage Module (42" x 17" x 16")	1
10	9604-3-01 Accessory Back Panel (for 42" Shelf Unit 14½" tall)	1
11	9893-7-01 REDZONE 3 Hook Cord or Tool Holder	1
12	9504-3-01 Shelf Door (for 42" Shelf Unit)	1
*13	975402-3-01 Van Shelf Mounting Kit - Chevy Express 155" WB	1

\* Not Shown

## HVAC / MECHANICAL

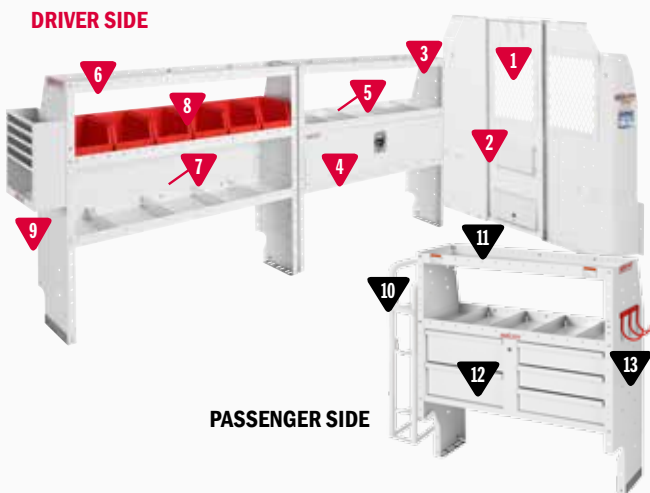

### 600-8123L HVAC/Mechanical Package

MODEL	DESCRIPTION	QUANTITY
1	96102-3-01 Screen Bulkhead - Full Size Van	1
2	96901-3-01 Swing Door Conversion Kit	1
3	9355-3-03 Adjustable 3 Shelf Unit (52" x 44" x 13½")	1
4	9505-3-01 Shelf Door (for 52" Shelf Unit)	1
5	9605-3-01 Accessory Back Panel (for 52" Shelf Unit 14½" tall)	1
6	9356-3-03 Adjustable 3 Shelf Unit (60" x 44" x 13½")	1
7	9606-3-01 Accessory Back Panel (for 60" Shelf Unit 14½" tall)	1
8	9859-7-01 REDZONE Medium 6 Bin Set (13")	1
9	9880-3-01 Literature Holder 6 Compartment	1
10	9863-3-01 Refrigerant Tank Rack (2x 30#, 1x 50#)	1
11	9381-3-03 Heavy Duty Shelf Unit (for Secure Storage Modules - 42" x 44" x 16")	1
12	9045-3-02 5 Drawer Secure Storage Module (42" x 17" x 16")	1
13	9893-7-01 REDZONE 3 Hook Cord or Tool Holder	1
*14	975402-3-01 Van Shelf Mounting Kit - Chevy Express 155" WB	1

\* Not Shown

## ELECTRICAL

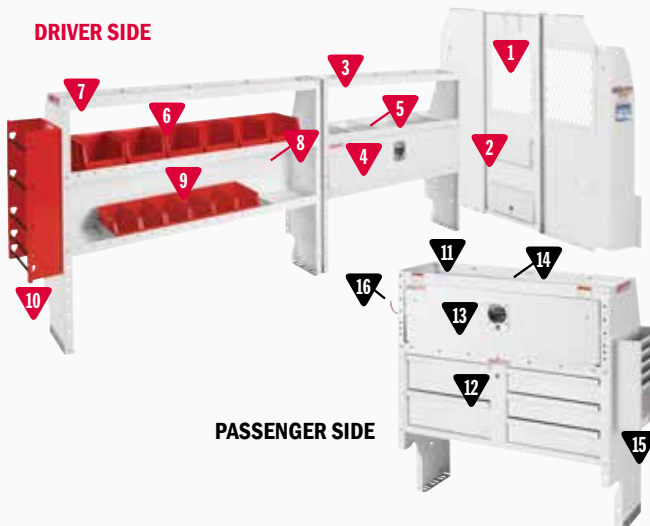

### 600-8124L Electrical Package

MODEL	DESCRIPTION	QUANTITY
1	96102-3-01 Screen Bulkhead - Full Size Van	1
2	96901-3-01 Swing Door Conversion Kit	1
3	9355-3-03 Adjustable 3 Shelf Unit (52" x 44" x 13½")	2
4	9505-3-01 Shelf Door (for 52" Shelf Unit)	2
5	9605-3-01 Accessory Back Panel (for 52" Shelf Unit 14½" tall)	1
6	9859-7-01 REDZONE Medium 6 Bin Set (13")	1
7	9356-3-03 Adjustable 3 Shelf Unit (60" x 44" x 13 ½")	1
8	9606-3-01 Accessory Back Panel (for 60" Shelf Unit 14½" tall)	1
9	9858-7-01 REDZONE Small 6 Bin Set (13")	1
10	9882-7-01 REDZONE Wire Spool Holder End Mount	1
11	9381-3-03 Heavy Duty Shelf Unit (for Secure Storage Modules - 42" x 44" x 16")	1
12	9045-3-02 5 Drawer Secure Storage Module (42" x 17" x 16")	1
13	9504-3-01 Shelf Door (for 42" Shelf Unit)	1
14	9604-3-01 Accessory Back Panel (for 42" Shelf Unit 14½" tall)	1
15	9880-3-01 Literature Holder 6 Compartment	1
16	9893-7-01 REDZONE 3 Hook Cord or Tool Holder	1
*17	975402-3-01 Van Shelf Mounting Kit - Chevy Express 155" WB	1

\* Not Shown

# CHEVROLET CITY EXPRESS PACKAGES

Keep it simple with room for the busiest days or fully load it up with shelves, drawers and bins to keep everything organized. Your City Express van works just as hard any other van on the road. Customize for your needs with accessories starting on page 13.

**NEW! AVAILABLE JUNE 2018**



## City Express Mounting Kit

- Heavy gauge steel mounting plates distribute shelf load and provide secure mounting to van interior
- Mounts directly to reinforced weld nuts and cargo tie-downs or into existing holes (no drilling)
- Faster installation with reduced risk of damage to van during installation

MODEL	DESCRIPTION	WEIGHT
9754-3-01	Rear Shelf Mounting Kit - City Express	13 lbs.
975403-3-01	Driver Side Mounting Kit - City Express	13 lbs.
975404-3-01	Passenger Side Mounting Kit - City Express	15 lbs.

## COMMERCIAL / BASE

DRIVER SIDE



PASSENGER SIDE

## 600-8320 Commercial Shelving Package

MODEL	DESCRIPTION	QUANTITY
1	96114-3-01 Mesh Bulkhead - Chevy City Express	1
2/2	9353-3-03 Adjustable 3 Shelf Unit (36" x 44" x 13½")	2
3/3	9603-3-01 Accessory Back Panel (36" x 14½")	4
*4	9754-3-01 Rear Shelving Mounting Kit - City Express	1

\* Not Shown

## GENERAL SERVICE

DRIVER SIDE

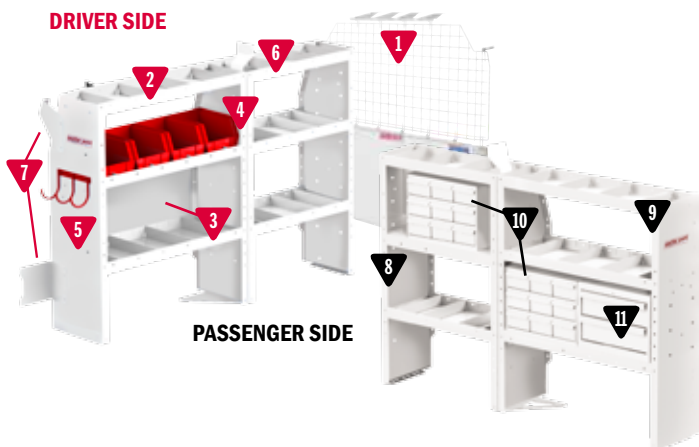

PASSENGER SIDE

## 600-8321 General Service Package

MODEL	DESCRIPTION	QUANTITY
1	96114-3-01 Mesh Bulkhead - Chevy City Express	1
2	9353-3-03 Adjustable 3 Shelf Unit (36" x 44" x 13½")	1
3	9603-3-01 Accessory Back Panel for 36" Shelf Unit (14½" tall)	1
4	9859-7-01 REDZONE Medium 6 Bin Set (13")	1
5	9893-7-01 REDZONE 2 Hook Holder (5" diameter)	1
6	9352-3-03 Adjustable 3 Shelf Unit (28" x 44" x 13½")	1
7	975403-3-01 Driver Side Shelf Mounting Kit - City Express	1
8	9352-3-03 Adjustable 3 Shelf Unit (28" x 44" x 13½")	1
9	9353-3-03 Adjustable 3 Shelf Unit (36" x 44" x 13½")	1
10	9909-3-02 Parts Cabinet 9 Bin Set (16" x 14" x 12")	2
11	9912-3-02 2 Drawer Cabinet (16" x 14" x 12")	1
*12	975404-3-01 Passenger Side Mounting Kit - City Express/NV200	1

\* Not Shown



# PLUMBING

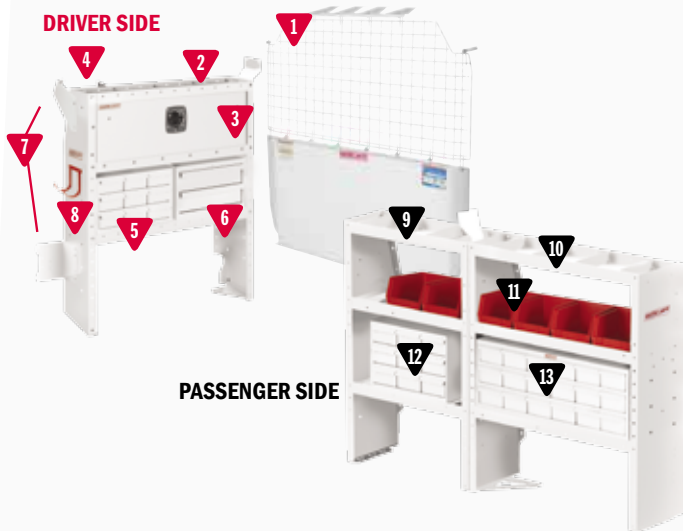

## 600-8322 Cable/Plumber Package

MODEL	DESCRIPTION	QUANTITY
1	96114-3-01 Mesh Bulkhead - Chevy City Express	1
2	9353-3-03 Adjustable 3 Shelf Unit (36" x 44" x 13½")	1
3	9503-3-01 Shelf Door (for 36" shelf unit)	1
4	9603-3-01 Accessory Back Panel (for 36" shelf unit 14½" tall)	1
5	9909-3-02 Parts Cabinet 9 Bin (16" x 12" x 12")	1
6	9912-3-02 2 Drawer Cabinet (16" x 14" x 12")	1
7	975403-3-01 Driver Side Mounting Kit - NV200/City Express	1
8	9892-7-01 REDZONE 2 Hook Holder (5" diameter)	1
9	9352-3-03 Adjustable 3 Shelf Unit (28" x 44" x 13½")	1
10	9353-3-03 Adjustable 3 Shelf Unit (36" x 44" x 13½")	1
11	9859-7-01 REDZONE Medium 6 Bin Set (13")	1
12	9909-3-02 Parts Cabinet 9 Bin (16" x 12" x 12")	1
13	9918-3-02 Parts Cabinet 18 Bin (32" x 12" x 12")	1
*14	975404-3-01 Passenger Side Mounting - Kit NV200/City Express	1

\* Not Shown

# HVAC / MECHANICAL

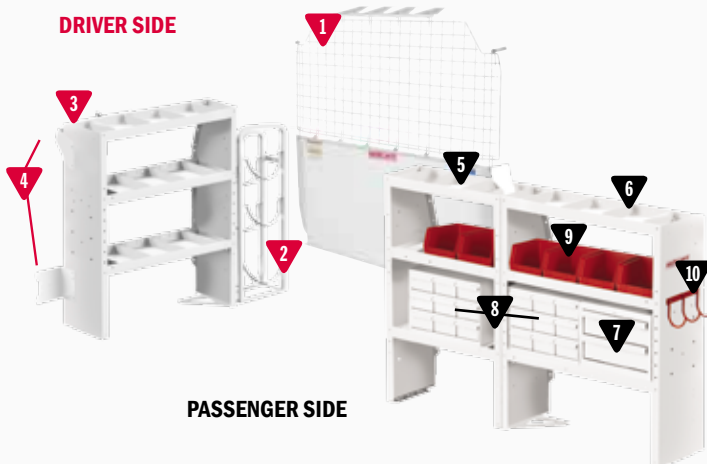

## 600-8323 HVAC/Mechanical Package

MODEL	DESCRIPTION	QUANTITY
1	96114-3-01 Mesh Bulkhead - Chevy City Express	1
2	9863-3-01 Refrigerant Tank Rack (2x 30#, 1x 50#)	1
3	9353-3-03 Adjustable 3 Shelf Unit (36" x 44" x 13½")	1
4	975403-3-01 Driver Side Mounting Kit - NV200/City Express	1
5	9352-3-03 Adjustable 3 Shelf Unit (28" x 44" x 13½")	1
6	9353-3-03 Adjustable 3 Shelf Unit (36" x 44" x 13½")	1
7	9912-3-02 2 Drawer Cabinet (16" x 14" x 12")	1
8	9909-3-02 Parts Cabinet 9 Bin (16" x 12" x 12")	2
9	9859-7-01 REDZONE Medium 6 Bin Set (13")	1
10	9893-7-01 REDZONE 3 Hook Cord or Tool Holder	1
*11	975404-3-01 Passenger Side Mounting Kit - NV200/City Express	1

\* Not Shown

# ELECTRICAL

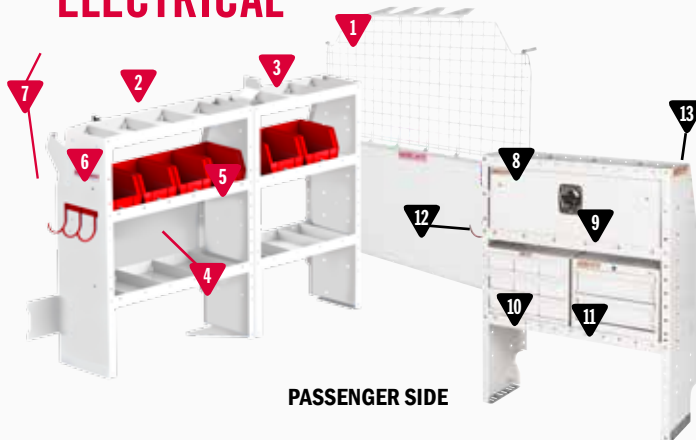

## 600-8324 Electrical Package

MODEL	DESCRIPTION	QUANTITY
1	96114-3-01 Mesh Bulkhead - Chevy City Express	1
2	9353-3-03 Adjustable 3 Shelf Unit (36" x 44" x 13½")	1
3	9352-3-03 Adjustable 3 Shelf Unit (28" x 44" x 13½")	1
4	9603-3-01 Accessory Back Panel (for 36" shelf unit 14½" tall)	1
5	9859-7-01 REDZONE Medium 6 Bin Set (13")	1
6	9893-7-01 REDZONE 3 Hook Cord or Tool Holder	1
7	975403-3-01 Driver Side Mounting Kit - NV200/City Express	1
8	9353-3-03 Adjustable 3 Shelf Unit (36" x 44" x 13 ½")	1
9	9503-3-01 Shelf Door for (36" shelf unit)	1
10	9909-3-02 Parts Cabinet 9 Bin (16" x 12" x 12")	1
11	9912-3-02 2 Drawer Cabinet (16" x 14" x 12")	1
12	9893-7-01 REDZONE 3 Hook Cord or Tool Holder	1
*13	975404-3-01 Mounting Kit - NV200/City Express	1

\* Not Shown

# BULKHEADS

Our van bulkheads allow you to separate the driver compartment from the cargo area for maximum protection against shifting loads. Exclusive polycarbonate windows improve visibility and safety. Tighter panel design ensures cabin comfort, both noise and temperature. Several bulkhead accessories are available to keep you organized.



## Bulkhead for GM Full Size Van

MODEL	DESCRIPTION	WEIGHT
96101-3-01	Window Bulkhead	67 lbs.
96102-3-01	Screen Bulkhead	67 lbs.
96901-3-01	Swing Door Conversion Kit with lockable door latch	3 lbs.
96903-3-01	Solid Bulkhead Panel Adapter Kit	10 lbs.

## Bulkhead for Chevrolet City Express Van

Window bulkheads offer unobstructed visibility of the cargo area, side door, and rear door. Maximizes comfort in the passenger area. Lightweight mesh bulkheads deliver full driver and cargo protection.

MODEL	DESCRIPTION	WEIGHT
96114-3-01	Chevy City Express Mesh Bulkhead	35 lbs.
96514-3-01	Chevy City Express Window Bulkhead	40 lbs.

## DESIGNED WITH THE PROFESSIONAL IN MIND

WEATHER GUARD® Van Solutions are ready to roll with game changing improvements based on years of research and your input. Completely retooled shelving, improved bulkheads, customizable organizational features, and a host of smart new accessories, designed around the common sense idea that tools and equipment belong on the shelf, not the floor.



# ADJUSTABLE SHELVING

Durable, professional grade WEATHER GUARD® Van Shelving takes it to the max! Maximum customization and capacity, for maximum productivity. Shelves can be adjusted quickly without removing them from the van. Assembly and installation is faster and easier than before.

## 17° TAPERED END PANEL CLOSER FIT

for more working space inside the van

## DEEP FULLY HEMMED SHELVES

sized for tools, equipment, and other materials

## EASY TO CUSTOMIZE

with pre-punched mounting holes for WEATHER GUARD® accessories and cabinets

## EASY TO ASSEMBLE AND "STALL"

with captive nuts on each shelf and complete "stallation hardware



## ADJUSTABLE DIVIDERS

Includes pack of four adjustable dividers for each shelf

## PUNCHED SHELVES

for easier "stallation of accessory cabinets

## FRONT FLOOR CLEARANCE (16" SHELVES ONLY)

for material storage. Fits PACK RAT® Drawer Units

## UNMATCHED DURABILITY

achieved with heavy duty 18 gauge steel construction

## FLAT FRONTS

on 13½" deep adjustable shelves. Mount doors and accessories at floor level

**WEATHER GUARD® EXCLUSIVE!**

## Shelf Units: Ships complete in one carton

MODEL	HEIGHT	WIDTH	DEPTH	SHELVES	DIVIDERS	WEIGHT
9333-3-03	34"	36"	13½"	2	8	48 lbs.
9334-3-03	34"	42"	13½"	2	8	48 lbs.
9335-3-03	34"	52"	13½"	2	8	72 lbs.
9336-3-03	34"	60"	13½"	2	8	70 lbs.
9343-3-03	44"	36"	16"	3	12	74 lbs.
9344-3-03	44"	42"	16"	3	12	80 lbs.
9345-3-03	44"	52"	16"	3	12	85 lbs.
9346-3-03	44"	60"	16"	3	12	104 lbs.
<b>NEW!</b> 9352-3-03	44"	28"	13½"	3	12	50 lbs.
9353-3-03	44"	36"	13½"	3	12	53 lbs.
9354-3-03	44"	42"	13½"	3	12	57 lbs.
9355-3-03	44"	52"	13½"	3	12	66 lbs.
9356-3-03	44"	60"	13½"	3	12	73 lbs.

## REDZONE Accessories End panel and shelf

MODEL	DESCRIPTION	WEIGHT
<b>1</b> 8866	Fire extinguisher	6 lbs.
<b>2</b> 9887-7-01	Extension cord brackets (3)	2 lbs.
<b>3</b> 8875	Hard hat bracket (hat not included)	2 lbs.
8841	Shelf mat, narrow	1 lb.
<b>4</b> 9836	Shelf mat, wide	1 lb.
<b>5</b> 9880-3-01	Literature holder	11 lbs.



See page 14 for accessories A-E.

**NEW ITEMS AVAILABLE JUNE 2018**

# SECURE STORAGE

Add extra security and theft-resistance for valuable tools and equipment with WEATHER GUARD® Secure Storage shelf units. Multiple door and drawer modules easily assemble into REDZONE Shelving. Our welded steel construction and heavy-duty locking mechanism ensures peace of mind on the job or in the parking lot.

Select the shelf unit to fit your van, then the storage module to fit your needs.

## Secure Storage Shelf Units (42" Wide)

MODEL		HEIGHT	DIVIDERS	WEIGHT
9381-3-03	Full Size Vans	44"	8	104 lbs.
<i>Includes end panel and top shelf for secure storage unit</i>				
9391-3-03	High Roof Vans	60"	12	108 lbs.
<i>Includes end panels, top and center shelf for secure storage unit</i>				
9040-3-01	Door Module			47 lbs.
9045-3-02	5 Drawer Module			78 lbs.

## Secure Storage Service Parts

MODEL	DESCRIPTION	WEIGHT
70206-xx	Replacement Lock Kit	117 lbs.
70210-xx	Key Kit	1 lb.
70211-xx	Replacement D Handle Kit	1 lb.

xx- Designates key code. Specify key code 11-20 when ordering



Door Module  
9040-3-01



5 Drawer  
Module  
9045-3-02

**NEW!**

## SHELVING MOUNTING KITS



**UNIQUE 4-WAY STOP**  
*restricts movement*

**SECURE INSTALLATION**  
*evens out load spread*

**OPEN FLOOR MOUNT**  
*no floor rail to get in the way*



**STEEL MOUNTING PLATES**  
*distributes shelf load*

**MOUNTS TO EXISTING HOLES**

**FAST INSTALLATION**  
*no drilling needed*

### Chevy Express/GMC Savana Shelving Mounting Kit

- Unique 4-way stop combines mounting straps with steel brackets to resist front and back and side to side movement
- Secure installation - upper extruded aluminum rail spreads load across van wall
- Patent pending twist plates for easier shelf placement along van wall
- Open floor mounting - no floor rail to interfere with wide or bulky items under the bottom shelf

MODEL	DESCRIPTION	WEIGHT
975401-3-01	135" WB Mounting Kit	18 lbs.
975402-3-01	155" WB Mounting Kit	20 lbs.

### City Express Shelving Mounting Kit

- Heavy gauge steel mounting plates distribute shelf load and provide secure mounting to van interior
- Kit mounts shelf units directly to reinforced weld nuts or factory holes in the van without drilling new holes
- Faster installation with reduced risk of damage to van

MODEL	DESCRIPTION	WEIGHT
9754-3-01	Complete Rear Mounting Kit	13 lbs.
975403-3-01	Driver Side Mounting Kit	15 lbs.
975404-3-01	Passenger Side Mounting Kit	15 lbs.

# ACCESSORIES



**Shelf Doors with High Security D Handle Lock**  
Mount to shelf units or to retainer lips. Single point D-handle lock for added security. Allow seven mounting holes shelf to shelf spacing

MODEL	HEIGHT	SHELF WIDTH	WEIGHT
<b>NEW!</b> 9502-3-01	11"	28"	10 lbs.
9503-3-01	11"	36"	13 lbs.
9504-3-01	11"	42"	17 lbs.
9505-3-01	11"	52"	21 lbs.
9506-3-01	11"	60"	25 lbs.

**Light Weight Shelf Back Panels**  
Use with shelf doors to turn a shelf into a cabinet

MODEL	HEIGHT	SHELF WIDTH	WEIGHT
<b>NEW!</b> 9602-3-02	7¾"	28"	2 lbs.
9603-3-02	7¾"	36"	2 lbs.
9604-3-02	7¾"	42"	3 lbs.
9605-3-02	7¾"	52"	4 lbs.
9606-3-02	7¾"	60"	5 lbs.
<b>NEW!</b> 9602-3-01	14½"	28"	4 lbs.
9603-3-01	14½"	36"	4 lbs.
9604-3-01	14½"	42"	6 lbs.
9605-3-01	14½"	52"	8 lbs.
9606-3-01	14½"	60"	10 lbs.

**Retainer Lips**  
Keeps items in place under shelf units

MODEL	HEIGHT	SHELF WIDTH	DEPTH	WEIGHT
<b>NEW!</b> 9702-3-02	1½"	28"	1½"	1 lb.
9703-3-02	1½"	36"	1½"	1 lb.
9704-3-02	1½"	42"	1½"	1 lb.
9705-3-02	1½"	52"	1½"	2 lbs.
9706-3-02	1½"	60"	1½"	2 lbs.

**End Panels**  
Can't find the shelf combination you need? Configure your own shelf system with end panels and accessory shelves.

MODEL	HEIGHT	WIDTH	DEPTH	WEIGHT
9243-3-01	36"	2"	13½"	22 lbs.
9244-3-01	44"	2"	13½"	18 lbs.
9246-3-01	60"	2"	13½"	33 lbs.
9274-3-01	44"	2"	16"	30 lbs.
9276-3-01	60"	2"	16"	34 lbs.

**Extra Shelves**  
Includes one set of dividers

MODEL	HEIGHT	WIDTH	DEPTH	WEIGHT
<b>NEW!</b> 9142-3-01	2"	28"	13½"	10 lbs.
9143-3-01	2"	36"	13½"	14 lbs.
9144-3-01	2"	42"	13½"	18 lbs.
9145-3-01	2"	52"	13½"	22 lbs.
9146-3-01	2"	60"	13½"	26 lbs.
9163-3-01	2"	36"	16"	14 lbs.
9164-3-01	2"	42"	16"	18 lbs.
9165-3-01	2"	52"	16"	22 lbs.
9166-3-01	2"	60"	16"	26 lbs.



## Locking Storage & CATV Cabinets

MODEL	SHELVES	HEIGHT	WIDTH	DEPTH	WEIGHT
<b>1</b> 9020-3-01	N/A	22"	18"	16"	25 lbs.
<b>2</b> 9021-3-01	2*	22"	18"	16"	35 lbs.

\*Removable Shelves



## Bin Sets

Sturdy plastic bins sized to fit 16" or 13" deep adjustable van shelving

MODEL	HEIGHT	WIDTH	DEPTH	BINS	WEIGHT
9854-7-01	5"	5½"	14¾"	9	8 lbs.
9855-7-01	7"	8¾"	14¾"	6	10 lbs.
9856-7-01	7"	16½"	14¾"	3	8 lbs.
9858-7-01	5"	5½"	10⅞"	6	8 lbs.
9859-7-01	7"	7"	10⅞"	6	8 lbs.



Model 89011

## Van Floor Mats

Floor mats protect the van floor from normal wear and tear, prevent cargo from shifting, and reduce noise.

MODEL	VAN TYPE	WEIGHT
89011	70" x 127" Rectangular Mat*	55 lbs.
89015	96 and newer Chevy Express/GMC Savana	55 lbs.

\*Must be cut to fit any style vans

**NEW ITEMS AVAILABLE JUNE 2018**

# ACCESSORIES

## ! CAB COMMAND CENTER



WEATHER GUARD® EXCLUSIVE!



Cab Command Center for  
Chevy Express/GMC Savana

MODEL	HEIGHT	WIDTH	DEPTH	WEIGHT
9012-3-01	18"	7½"	20"	30 lbs.

**RAISED MOUNTING BASE FOR 7" FLOOR CLEARANCE**  
with tamper-resistant Torx® head mounting bolts



**POWER PASS® ELECTRICAL PASS-THRU GROMMET**  
allows you to charge items within the box

**SECURE D HANDLE LOCKS**  
single point latching for theft-resistance

**SIMPLIFIED INSTALLATION**  
gets you back on the job quickly

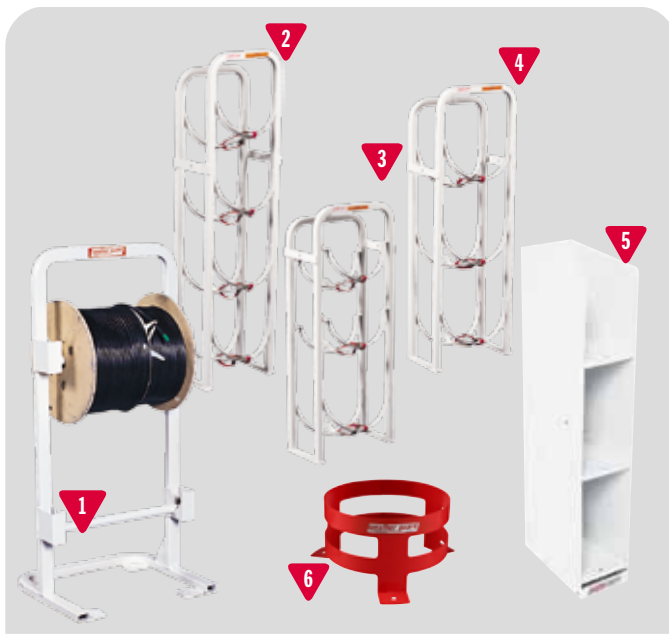

### Floor Mounted Accessories

MODEL	DESCRIPTION	HEIGHT	WIDTH	DEPTH	WEIGHT
1	9861-3-01 Cable Spool Holder	42½"	19¾"	16¾"	37 lbs.
2	9862-3-01 3-50 lb. Tank Holder	45½"	15½"	8"	31 lbs.
3	9863-3-01 2-30 lb., 1-50 lb. Tank Holder	40"	15½"	8"	27 lbs.
4	9864-3-01 4-30 lb. Tank Holder	48½"	13"	8"	31 lbs.
5	9860-3-01 Catalog File Unit	36"	6"	12"	16 lbs.
6	9885-7-01 5 Gal. Bucket Holder	6¾"	11¼"	11¼"	8 lbs.



**LIMITED QUANTITIES!**

### Door Trays and Literature Holders

MODEL	HEIGHT	WIDTH	DEPTH	WEIGHT	
1	9871-3-01	21¾"	20¼"	4⅝"	19 lbs.
2	9872-3-01	21¾"	20¼"	4⅝"	18 lbs.
3	9873-3-01	21¾"	20¼"	4⅝"	19 lbs.
4	9880-3-01	16"	13"	5"	11 lbs.

# REDZONE ACCESSORIES

Looking for parts and supplies won't slow you down with new and re-engineered REDZONE van storage accessories. Organizers and holders keep frequently used items in easy reach for maximum productivity. Tool cabinets, parts bin boxes, and locking storage keep small components organized.

**CUSTOMIZED ORGANIZATION**  
for supplies and tools

**HEAVY DUTY 18 GAUGE STEEL CONSTRUCTION**  
makes for tough, long lasting accessories

**POWDER COAT FINISH**  
provides durability

**EASY TO INSTALL**  
to shelf end panels, bulkheads, and door



## HOOKS AND BRACKETS

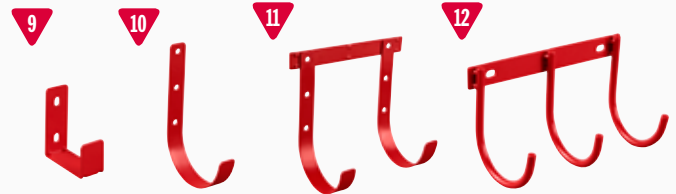

## REDZONE Accessories

	MODEL	DESCRIPTION	HEIGHT	WIDTH	DEPTH	WEIGHT
1	9874-7-01	Can Organizer	9.8"	12"	4"	3 lbs.
2	9879-7-01	Tool Organizer	5½"	15"	4"	3 lbs.
3	9881-7-01	Caulk Tube Tray	7½"	13½"	7½"	4¼ lbs.
4	9882-7-01	Wire Spool Holder End Mount	26"	14"	6"	12 lbs.
5	9883-7-01	Large Parts Bin	11"	13"	7"	10 lbs.
6	9884-7-01	Medium Parts Bin	6½"	13"	7"	8 lbs.
7	9885-7-01	5 Gallon Bucket Holder	6¼"	11¼"	11¼"	8 lbs.
8	9886-7-01	30# Refrigerant Tank Holder	10¾"	9¾"	9¾"	9 lbs.
9	9887-7-01	Ladder Holder	4"	1½"	3½"	¼ lb.
10	9891-7-01	Large Hook (5" diameter)	8"	1¾"	5"	½ lb.
11	9892-7-01	2 Hook Holder (5" diameter)	8"	9"	5"	½ lb.
12	9893-7-01	3 Hook Cord or Tool Holder	5¼"	9"	4½"	½ lb.

# CABINETS



## Mechanics Grade Tool Cabinets

High quality and durable mechanics-grade Tool Cabinets for your van feature easy-to-grip handles, smooth ball-bearing rollers, latches for each drawer, and secure locks that can be keyed alike. Bin Cabinets feature hook and loop fasteners to securely hold bins in place.

	MODEL	DRAWERS	HEIGHT	WIDTH	DEPTH	WEIGHT
1	9912-3-02	2	12"	16"	13.7"	26 lbs.
2	9914-3-02	4	12"	16"	13.7"	32 lbs.
3	9924-3-02	4	24"	16"	13.7"	48 lbs.
4	9928-3-02	8	24"	16"	13.7"	60 lbs.
5	9984-3-01	4	24"	18"	13.7"	53 lbs.
6	9988-3-01	8	24"	18"	13.7"	60 lbs.

## Cabinet Divider Kits

MODEL	DESCRIPTION	WEIGHT
9822-3-01	Divider and Liner Kit for 9914-3-02, 9928-3-02	2 lbs.
9824-3-01	Divider and Liner Kit for 9912-3-02, 9924-3-02	2 lbs.



## Parts Boxes & Bin Cabinets

	MODEL	BINS	HEIGHT	WIDTH	DEPTH	WEIGHT
1	9906-3-02	6	4½"	32½"	11¾"	18 lbs.
2	9909-3-02	9	12"	17"	11¾"	28 lbs.
3	9918-3-02	18	12"	32½"	11¾"	54 lbs.
4	9950-7-02*	N/A	12.6"	20.3"	14.4"	4 lbs.
5	9951-9-01	N/A	3"	18½"	13"	3 lbs.
Special Order Cabinets (Call for availability. Longer lead time required)						
6	8908-3	8	8½"	22 "	11¾"	24 lbs.

\*Parts cases not included



1 Invert shelf when assembling it and mount cabinet directly to shelf.

2 Keep shelf facing up and use Cabinet Mounting Spacer kit Model 9994.

## Cabinet Accessory Mounting

The new van shelf design includes cabinet mounting holes that make it easier to assemble and install. There are two fast ways to mount cabinet and parts boxes to van shelves.

MODEL	DESCRIPTION	WEIGHT
9822-3-01	Divider and Liner Kit for 9914-3-02, 9928-3-02	2 lbs.
9824-3-01	Divider and Liner Kit for 9912-3-02, 9924-3-02	2 lbs.



# DRAWER UNITS



## PACK RAT® Drawer Units

MODEL	HEIGHT	WIDTH	DEPTH	COMPARTMENTS	DIVIDERS	WEIGHT
<b>STEEL DRAWER UNITS</b>						
301-3	12½"	30"	24"	3	12	169 lbs.
303-3	12½"	39¾"	24"	4	12	217 lbs.
304-3	9"	30"	48"	2	6	220 lbs.
305-3	9"	10¼"	48"	1	6	106 lbs.
306-3	9"	20"	48"	2	12	179 lbs.
307-3	9"	30"	48"	3	18	247 lbs.
308-3	9"	39¾"	48"	4	24	322 lbs.
308-5	9"	39¾"	48"	4	24	322 lbs.
312-3	9"	30"	24"	3	12	151 lbs.
334-3	12½"	30"	48"	2	6	245 lbs.
335-3	12½"	10¼"	48"	1	6	130 lbs.
336-3	12½"	20"	48"	2	12	210 lbs.
337-3	12½"	30"	48"	3	18	294 lbs.
338-3	12½"	39¾"	48"	4	24	383 lbs.
338-5	12½"	39¾"	48"	4	24	383 lbs.
<b>ALUMINUM DRAWER UNITS</b>						
310-3-01	14½"	11¾"	42"	1	0	56 lbs.

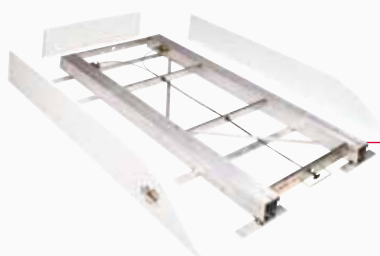

**FOR FULL-SIZE VAN & MINIVAN REAR DOOR**

Model 3200

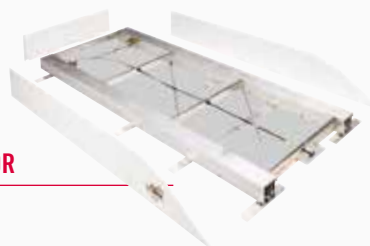

**FOR LONG WHEEL BASE FULL-SIZE VAN REAR DOOR**

Model 3400



## ITEMIZER® Drawer Units

These storage solutions conveniently increase your storage space by placing small equipment at your fingertips without the need to crawl inside the van. Drawer dividers provide an extensive array of organizing options.

- Lightweight Aluminum Drawers carry up to 75 lbs. each
- Units Can be stacked as needed for additional storage
- Roller mounted drawers glide open to full extension
- Adjustable drawer dividers offer greater flexibility
- Anti-Skid Strips provide traction for wet and muddy boots

MODEL	DRAWERS	HEIGHT	WIDTH	DEPTH	WEIGHT
314-3	1	6¾"	12¼"	49"	26 lbs.
316-3	2 Lateral	6¾"	24"	49"	55 lbs.
317-3	3 Lateral	6¾"	36"	49"	85 lbs.
318-3	4 Lateral	6¾"	48"	49"	110 lbs.
326-3	2 Stacked	12¼"	12¼"	49"	48 lbs.
327-3	3 Stacked	17¾"	12¼"	49"	71 lbs.
328-3	4 Stacked	23½"	12¼"	49"	92 lbs.

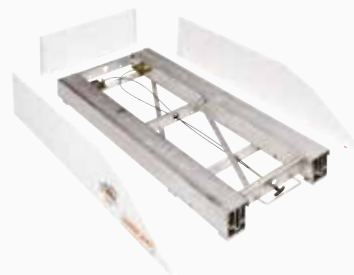

**FOR FULL-SIZE VAN SIDE DOOR**

Model 3100

## BED RAT® Sliding Platforms

MODEL	HEIGHT	WIDTH	DEPTH	WEIGHT
3100	4¾"	22"-44¾"	54"	97 lbs.
3200	4¾"	44¾"	68"	123 lbs.
3400	4¾"	44¾"	90"	155 lbs.

# EZGlide2™ DROP-DOWN LADDER RACK



## EASIEST TO OPERATE

**50% less effort** to operate than competitor drop-down ladder racks, reducing strain on the operator

## INCREASED PRODUCTIVITY

Get ladders off your van on the job faster and reduce worker fatigue and injuries

## LIGHTEST WEIGHT

Drop-down ladder rack available

- Maximize fuel economy
- Maximize carrying capacity

## MOST VERSATILE

- Up to 40' extension ladders
- 3' - 10' stepladders
- Conduit carriers

### STEP 1

## CHOOSE A MOUNTING KIT



Model 2085-0-01

### Mounting Channel Kits

All Mounting Channel Kits attach to factory mounting points. No drilling required. All hardware included.

MODEL	DETAILS	WEIGHT
2085-0-01	Mounting Channel Kit - Chevy City Express™	15 lbs.

### STEP 2

## SELECT A DROP-DOWN LADDER RACK ASSEMBLY (Single-Side Only with Crossmembers)

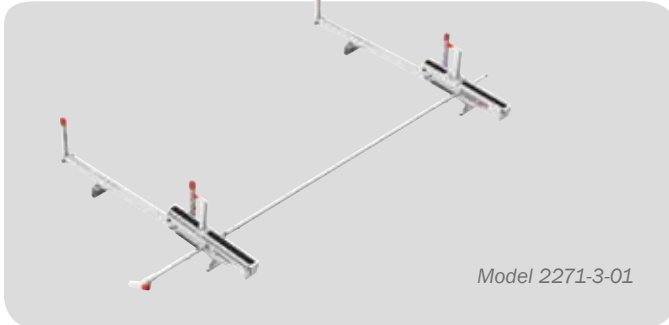

Model 2271-3-01

### Drop-Down Ladder Rack Assemblies

Drop-down can mount on driver or passenger side. Rack fits 16' to 40' Extension, 5' to 10' Step and 3' to 8' Podium, evenly distributed on ladder rack. Carry ladders appropriate to the size of the vehicle.

MODEL	DETAILS	WEIGHT
2271-3-01	Fixed Drop-Down - Full Size <i>(Includes two 70" Cross Members which can be set at 96" or 77" center to center)</i>	77 lbs.
2261-3-01	Fixed Drop-Down - Compact <i>(Includes two 60" Cross Members which can be set at 77" center to center)</i>	83 lbs.

Always properly secure ladders to the ladder rack while driving. Transporting ladders longer than the vehicle is not recommended.

## KITS AND ACCESSORIES

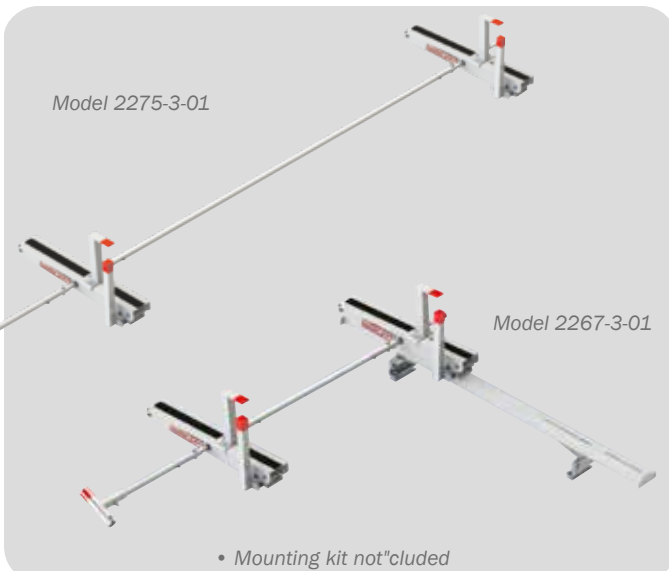

Model 2275-3-01

Model 2267-3-01

• Mounting kit not included

### Dual Drop-Down Ladder Rack Accessories

MODEL	DETAILS	WEIGHT
2275-3-01	Fixed Drop-Down Long Ladder Kit - Full Size <i>(Cross Members not included) For Cross Members set at 96" or 77" center to center. Installs to 2271-3-01</i>	51 lbs.
2277-3-01	Fixed Drop-Down Short Ladder Kit - Full Size <i>(Includes one 70" Cross Member which can be set at 42" center to center) Installs to 2271-3-01</i>	57 lbs.
2265-3-01	Fixed Drop-Down Long Ladder Kit - Compact <i>(Cross Members not included)</i>	58 lbs.
2267-3-01	Fixed Drop-Down Short Ladder Kit - Compact <i>(Includes one 60" Cross Member which can be set at 42" center to center) Installs to 2261-3-01</i>	61 lbs.
<b>NEW!</b> 2254D-3-01	Quick Clamp Add-on Kit - Driver Side	6 lbs.
<b>NEW!</b> 2254P-3-01	Quick Clamp Add-on Kit - Passenger Side	6 lbs.
2060-3-01	Accessory Cross Member - Compact (60" wide)	6 lbs.
2070-3-01	Accessory Cross Member - Full Size (70" wide)	6 lbs.

# VAN LADDER RACKS

WEATHER GUARD® Roof Racks are designed to mount through holes built into the new GM & Chevy City Express. Roof rack mounting kit includes stands and hardware to improve rooftop mounting.

## STEP 1 CHOOSE A MOUNTING KIT



Model 2085-0-01

### Mounting Channel Kits

All Mounting Channel Kits attach to factory mounting points. No drilling required. All hardware included.

MODEL	DETAILS	WEIGHT
2085-0-01	Mounting Channel Kit - Chevy City Express™	15 lbs.

## STEP 2 SELECT VAN RACK AND ACCESSORY CROSS MEMBERS



### Powder Coated Aluminum Rack for GM Full Size

MODEL	DETAILS	WEIGHT
209-3-03	70" All Purpose Rack	35 lbs.
2097-3-03	70" All Purpose Accessory Cross Member	19 lbs.



### Powder Coated Heavy Duty Steel Rack for GM Full Size

MODEL	DETAILS	WEIGHT
205-3	2 Cross Member Rack - White	42 lbs.
216-3	3 Cross Member Rack - White	62 lbs.
2056-3	Accessory Cross Member - White	23 lbs.



### Aluminum All Purpose Racks for Chevy City Express

MODEL	DETAILS	WEIGHT
218-3-03	60" All Purpose Rack	31 lbs.
222-3-03	60" All Purpose Accessory Cross Member	17 lbs.

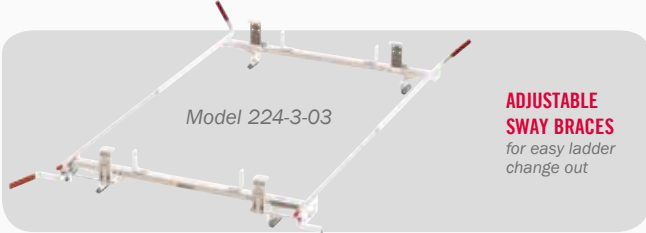

Model 224-3-03

**ADJUSTABLE SWAY BRACES**  
for easy ladder change out

### ! Quick Clamp Racks for Chevy City Express

MODEL	DETAILS	WEIGHT
223-3-03	60" Single Quick Clamp Rack (curb-side only)	44 lbs.
224-3-03	60" Dual Quick Clamp Rack	54 lbs.
225-3-03	60" Quick Clamp Accessory Cross Member	16 lbs.
234-3-01	Dual Quick Clamp Rack (street side/curb side)	76 lbs.
233-3-01	Quick Clamp Accessory Cross Member Fits Models 234-3-01, 236-3-01	21 lbs.



Model 250

### Sliding Ladder Rack

Our Sliding Ladder Rack provides quick and easy ladder storage inside your van. Rugged and durable, this rack fits up to 8-foot step, extension ladders when mounted to the roof.

MODEL	DETAILS	WEIGHT
250	Sliding Ladder Rack	27 lbs.

# CONDUIT CARRIERS



Model 239

Model 237



Model 238

### Aluminum Conduit Carrier

Keep your conduit safe, secure, and clean with our lightweight and durable Conduit Carrier.

MODEL	DETAILS	LENGTH	WIDTH	HEIGHT	WEIGHT
237	Conduit Carrier	121½"	11"	6"	40 lbs.
238	Extension	6"	11"	6"	4 lbs.
239	PVC Conduit Carrier Kit				4 lbs.

PVC not included. Separately purchase a section of standard 6" PVC (9ASTM D2665) plastic drain pipe. Coordinate the length of the PVC with the length of conduit you'll be carrying.



## CHEVROLET EXPRESS / GMC SAVANA

The dimensions show in this guide refer to model year 2019 and earlier Chevrolet Express and GMC Savana vans. Always measure your van carefully to make sure that the equipment you choose will fit properly. Verify the location of the gas tank, brake lines, wiring harness, etc. before installing any equipment. Shelving Mounting Kits are recommended. Do not exceed the van manufacturer's roof load rating.

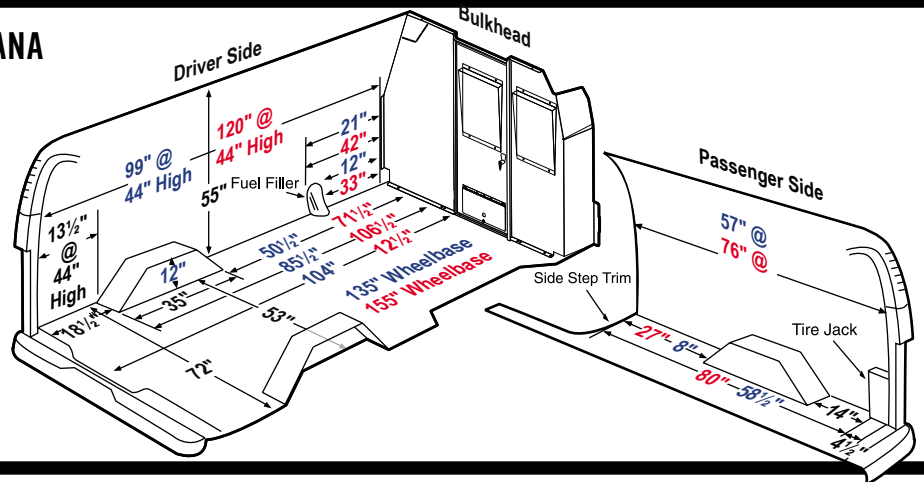

■ 135" Wheel Base ■ 155" Wheel Base

## CHEVROLET CITY EXPRESS / NISSAN NV200

The dimensions show in this guide refer to model year 2019 and earlier Chevrolet City Express and Nissan NV200 vans. Always measure your van carefully to make sure that the equipment you choose will fit properly. Verify the location of the gas tank, brake lines, wiring harness, etc. before installing any equipment. Shelving Mounting Kits are recommended. Do not exceed the van manufacturer's roof load rating.

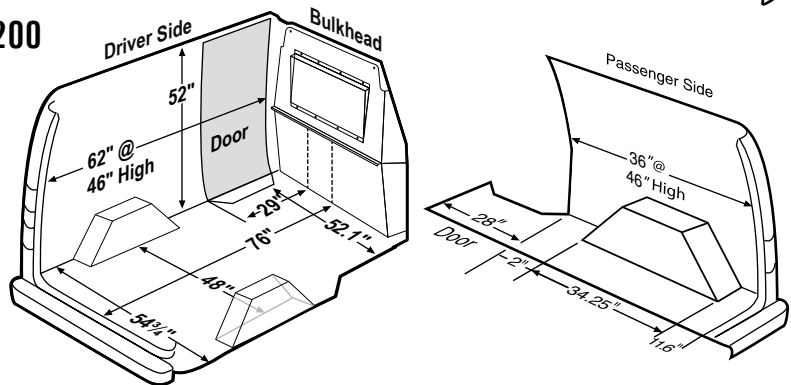

■ 115" Wheel Base

Always measure your van carefully to make sure that the equipment you choose will fit properly. Verify the location of the gas tank before installing any equipment. Shelving Mounting Kits are recommended. Do not exceed the van manufacturer's roof load rating.



### LIMITED LIFETIME WARRANTY

Knaack LLC (the Manufacturer) warrants to the original purchaser, only, that WEATHER GUARD® van products (the "WEATHER GUARD Product") will be free from defects in material and workmanship from the date of purchase and continuing for the expected lifetime of the WEATHER GUARD Product. Please call our customer service department toll free at 1.800.456.7865 with any questions or comments.

DO NOT use these products for storing or transporting flammables, explosives, hazardous materials or waste, such as gasoline, solvents, gun powder, dynamite, gases or any tanks, torches or gas powered equipment. These products are intended and safe for storing and transporting small tools and other non-combustible, non-flammable materials. Any modification made to, or unintended use of, these products may create a dangerous condition causing death, serious bodily injury or property damage.

#### NOTICE

Any modification or unintended use of these products shall immediately void all manufacturers warranties. Manufacturer disclaims all liability for injuries to persons or property resulting from any modification to, or unintended use of these products.

Ford Transit Connect, Nissan NV, Mercedes Sprinter, and Dodge RAM CV are registered trademarks of their respective owners.

For information on the WEATHER GUARD® Van Solutions Limited Lifetime Warranty, visit [www.weatherguard.com](http://www.weatherguard.com)  
To order more WEATHER GUARD® Van Solutions OEM brochures, please call us at **800.456.7865**



©2019 Knaack, LLC. All rights reserved.

CONTACT YOUR LOCAL DISTRIBUTOR/UPFITTER